

TOSHIBA
Pocket PC e310
User's Manual

Introduction

Thank you very much for your purchase of this Toshiba pocket personal computer.

Please be sure to read this user's manual before using the Toshiba Pocket PC, and ensure that you are aware of the correct handling procedures.

- Please be sure to read the "Safety precautions" section in this document to learn about important safety issues.
- After reading this document, keep it in a convenient place for future reference.

Copyright Information

© 2002 by Toshiba Corporation. All rights reserved. Under the copyright laws, this manual cannot be reproduced in any form without the prior written permission of Toshiba. No patent liability is assumed, with respect to the use of the information contained herein.

TOSHIBA Pocket PC e310 User's Manual

First edition March 2002

Trademarks

Microsoft, ActiveSync, Outlook, Pocket Outlook, Windows, Windows NT, and the Windows logo are either registered trademarks or trademarks of Microsoft Corporation in the United States and/or other countries. Microsoft products are licensed to OEMs by Microsoft Licensing, Inc., a wholly owned subsidiary of Microsoft Corporation.

Safety precautions

- Please carefully read “Safety precautions” before using the Toshiba Pocket PC and ensure that you are aware of correct handling procedures.
- The precautions provide essential information for the protection of the user and others from possible injury and property damage. They also provide information on the safe handling of this product .
- Please check that you fully understand the definition of the following messages (signs and graphical symbols) before reading the text, and always follow the instructions provided.

Supplementary Information: “The product complies with the requirements of the Low Voltage Directive 73/23/EEC and the EMC Directive 89/336/EEC.”

Weitere Informationen: “Das Produkt entspricht den Anforderungender Niederspannungs Richtlinie 73 23/EG und der EMCRichtlinie 89/336/EG.”

Informations complémentaires: “Ce produit est conforme aux exigences de la directive sur les basses tensions 73/23/CEE et de la directive EMC 89/336/CEE.”



Información complementaria: “El Producto cumple los requisitos de baja tensión de la Directiva 73/ 23/CEE y la Directiva EMC 89/336/CEE.”

Ulteriori informazioni: “Il prodotto é conforme ai requisiti della direttiva sulla bassa tensione 73/23/EG e la direttiva EMC 89/336/EG.”

Ytteligare information: “Produkten uppfyller kraven enligt lågspänningsdirektiver 73/23/EEC och EMC-direktiv 89/336/EEC.”

Explanation of signs

Signal icons for WARNING, CAUTION, and NOTE, will be followed by important safety information that must be carefully reviewed.

Icon	Meaning
	WARNING Indicates a potentially hazardous situation, which could result in death or serious injury ⁽¹⁾ if you do not follow instructions.
	CAUTION Indicates a potentially hazardous situation, which if not avoided, can result in minor injury ⁽²⁾ or property damage ⁽³⁾ .
	NOTE Gives you helpful information.

*1: Serious injury corresponds to an injury that leaves some aftereffect, and requires hospital treatment or long term treatment as an outpatient such as blindness, injuries, burns (high temperature, low temperature), electric shock, fractures, poisoning, etc.

*2: Minor injury corresponds to an injury that does not require hospital treatment or long term treatment as an outpatient, that is to say, injuries, burns, electric shock, etc.

*3: Property damage corresponds to the extensive damage with regard to the house structure, household goods, livestock, pets, etc.

Limitation of liability

- Toshiba Corporation is in no way liable for any damage resulting from earthquakes, fire, actions on the part of a third party, other accidents beyond the control of Toshiba Corporation or intentional acts, negligence or misuse on the part of the user or any usage under abnormal conditions.
- Toshiba Corporation is in no way liable for any damage, including but not limited to change or loss of stored data, loss of business profit, lost profits, interruption of business, or lost communication opportunities that are caused by usage or non-usability of this product.
- Toshiba Corporation is in no way liable for any damage resulting from failure to comply with the contents of this instruction manual.
- Toshiba Corporation is in no way liable for any damage resulting from malfunction due to usage in combination with connection devices, software, or devices other than those provided by Toshiba Corporation with the product.

Handling the unit (including the built-in batteries)

WARNINGS

- Turn the power off in areas where usage is prohibited, such as onboard aircraft or in a hospital and do not use the pocket PC. Usage in such areas can cause an accident due to negative effects on equipment such as aviation equipment onboard or medical equipment.
- Keep the pocket PC no less than 22 cm away from persons with a heart pacemaker implant when using the device in combination with a mobile phone. Failure to maintain this distance can cause an accident due to negative effects on the pacemaker at close proximity.
- Do not use the pocket PC when driving a car, etc. or while walking. Usage when driving a car or while walking can cause a traffic accident or injury.
- Do not allow metallic objects, such as staples and clips, to enter inside the pocket PC.
- Do not connect the terminals (metallic parts) with metallic objects. Entry of or contact with foreign objects can cause heat generation or ignition.

- If the pocket PC emits an unusual smell or sound, or generates smoke, turn the battery switch to the off position immediately and disconnect the AC adaptor from the power outlet.

Continued use of the pocket PC under any of these conditions can cause fire.

Please contact the dealer from whom the pocket PC was purchased and request inspection or repair service.

- Do not use or store in the following locations.
 - Locations such as a bathroom where the pocket PC can be subjected to water splashes or conditions of high humidity.
 - Locations where rain, fog, etc. can enter directly.
 - Locations subject to high temperatures, such as near to a fire or heating equipment.
 - Locations exposed to direct sunlight.
 - Inside a tightly closed car under hot sunlight.

The built-in battery can suffer liquid leakage, ignition, or rupture.

- Do not drop the pocket PC or allow the pocket PC to be subjected to any severe shock.

The built-in battery can suffer liquid leakage, ignition, or rupture.

- If the built-in battery leaks liquid, or emits an unusual smell, remove it immediately from the vicinity of any source of fire.

Continued use of the pocket PC under any of these conditions can cause ignition of the leaked liquid, or rupture.

- If liquid leaks from the built-in battery, do not touch it.

If such liquid is allowed to come into contact with the skin, it can cause eye or skin injuries. If the liquid should enter the eyes, irrigate the eyes thoroughly with clean water and immediately seek medical attention. If the liquid should come into contact with the skin or clothing, wash it away immediately with clean water.

- Do not disassemble, remodel or repair.

Disassembly, remodeling, or repair can cause injury.

Please contact the dealer from whom the pocket PC was purchased and request repair service.

CAUTIONS

- When using the pocket PC with the earphone (sold separately) connected to it, do not raise the sound volume level too high.
Raising the sound to high volume levels can impair your hearing ability.
- If the display is broken, and the liquid crystal (liquid) leaks out, do not touch it.
In the event of contact with the skin, the liquid crystal can cause a rash on the skin. If the liquid crystal should come into contact with the skin or clothing, wash it off immediately with clean water.
- Keep the pocket PC out of the reach of infants.
Placing within the reach of infants can cause injury.

Handling AC adaptor, power cord, cradle

WARNINGS

- Use only the AC adaptor supplied with the pocket PC.
Using an AC adaptor other than that supplied can cause smoke or ignition.
- Insert the power plug to a household electric outlet.
When travelling abroad, never plug the AC Adaptor into a power source that does not correspond to both the voltage and the frequency specified on the rating plate of the unit, as equipment damage will result.
- Do not connect or disconnect the power plug with wet hands.
Connecting or disconnecting under these conditions can cause electric shock.
- Do not leave open containers filled with liquid, such as cups, near the AC adaptor.
Spilt liquid entering the pocket PC can cause ignition or electric shock.
- Do not use the pocket PC in locations, such as a bathroom, where it will be subjected to liquid splashes.
Exposure to liquid can cause ignition or electric shock.
- If dust is found on or around the pins of the power plug, turn off the pocket PC and disconnect the power plug from the outlet, then wipe off the dust using a dry cloth.
Dust accumulation on the power plug can cause fire due to loss of insulation.

- Do not disassemble, remodel, or repair.
Disassembly, remodeling, or repair can cause fire, electric shock, or injury.
Please contact the dealer from whom the pocket PC was purchased and request repair service.

CAUTIONS

- When unplugging the power plug from the outlet, disconnect the power cord by grasping the power plug itself.
Pulling out the power cord by grasping the cable can cause ignition or electric shock due to cable damage.
- When handling the power cord, observe the following rules.
 - Do not damage the power cord.
 - Do not tamper with the power cord.
 - Do not twist the power cord.
 - Do not forcibly bend the power cord.
 - Do not pull the power cord.
 - Do not overload the power cord.
 - Do not heat the power cord.
 - Do not place it close to heating apparatus.
 Failure to do so can cause fire or electric shock.
If you find that the power cord is damaged, please call the dealer from whom the pocket PC was purchased and purchase a new power cord.
- Do not connect terminals (metallic parts) with metallic objects, such as wires.
Connecting the terminals (metallic parts) with metallic objects can cause heat generation or burns.
- Keep the pocket PC out of the reach of infants.
Placing within the reach of infants can cause injury.

NOTES

- Use the pocket PC only in locations with the following ambient environmental conditions.
When operating Temperature 0°C to 40°C, Humidity 30% to 80%
When charging Temperature 5°C to 35°C
- Do not use or store the Pocket PC in the following locations.
 - Locations subject to extremely high or low temperatures
 - Dusty locations
 - Locations subject to strong vibration
 Usage or storage in such locations can cause failure, malfunction, or loss of stored data.

- Do not allow the Pocket PC to be subjected to sharp temperature changes.
The resulting moisture condensation can cause failure, malfunction, or loss of stored data.
If moisture condensation is generated, use the Pocket PC only after allowing it to dry completely.
- When charging the battery, the case of the AC adaptor can become warm, but this is not abnormal.
- Disconnect the power plug from the outlet when not in use.
- Avoid inadvertently sitting while the Pocket PC is inserted in the back pocket of trousers, etc.
Sitting under these circumstances can cause damage or failure.
- Do not place objects or drop them on top of the Pocket PC.
When the pocket PC is placed in a bag containing heavy items, do not allow it to be caught underneath them.
Placing it under these conditions can cause damage or failure.
- Clean the terminals (metallic parts) occasionally with a Q-tip.
Dirty terminals can cause disconnection or poor charging.
- Do not use organic solvents such as benzene or thinner to clean the Pocket PC.
Use of these solvents can cause deformation or discoloration.
Wipe dirty parts with a soft dry cloth.
- Do not wipe the display with a wet cloth. Do not touch it with wet hands.
Wiping or touching under these conditions can cause failure or malfunction.
Wipe the display with a soft dry cloth.
- It is recommended that important data stored in the unit should be either noted down occasionally, or saved to a memory card (sold separately) or personal computer (data transfer with Active Sync).
The following can result in loss of stored data.
 - Misuse of the Pocket PC
 - Subjecting the main unit to the effects of static electricity or electric noise
 - Total loss of charge in the built-in battery due to an extended period of non-use
 - Failure or repair servicing of the Pocket PC
- Toshiba Corporation is in no way liable for change or loss of stored data resulting from failure or repair of the unit. Please understand this before usage.

- When using the optional (sold separately) “SD memory card”, please be sure to read the relevant instruction manual and ensure that you are aware of correct handling procedures.
 - Do not allow the card to be subjected to any severe shock while connected to the unit. Such shocks can cause damage or failure.
 - Do not carry the unit with the card still connected.

Carrying the unit with the card connected can cause loss of the card due to it falling from the unit.

- A lithium ion battery is used as the built-in battery. Please request the dealer from whom the Pocket PC was purchased to replace the built-in battery when this becomes necessary. Lithium ion batteries are recyclable. When you replace your built-in battery, please request that the repair center recycle the battery. Never dispose of the battery with ordinary waste.



The battery is a lithium ion battery, which can explode if not properly replaced, used, handled or disposed of. Dispose of the battery as required by local ordinances or regulations. Use only batteries recommended by Toshiba as replacements.

Working environment

This product was designed to fulfill the EMC (electromagnetic compatibility) requirements for “residential, commercial and light industry environments”.

Toshiba does not approve the use of this product in working environments other than “residential, commercial and light industry environments”.

For example, the following environments are not approved:

- Industrial Environments (environments with a mainvoltage >230V~)
- Medical Environments
- Automotive Environments
- Aircraft Environments

Any consequences resulting from the use of this product in working environments that are not approved are not the responsibility of Toshiba Corporation. The consequences of the use of this product in non-approved working environments may be:

- Interference with other devices or machines in the nearby surrounding area
- Malfunction of, or data loss from, this product caused by disturbances generated by other devices or machines in the nearby surrounding area

Therefore Toshiba strongly recommends that the electromagnetic compatibility of this product be suitably tested in all non-approved working environments before use. In the case of automobiles or aircraft, the manufacturer or airline respectively should be asked for permission before use of this product.

Furthermore, for general safety reasons, the use of this product in environments with explosive atmospheres is not permitted.

CE compliance

This product and the original options are designed to observe the related EMC (Electromagnetic compatibility) and safety standards. However, Toshiba cannot guarantee that this product still observes these EMC standards if options or cables not produced by Toshiba are connected or implemented. In this case, the persons who have connected / implemented those options / cables have to make sure that the system (PC plus options / cables) still fulfils the required standards. To avoid general EMC problems, the following advice should be observed:

- Only CE marked options should be connected / implemented
- Only best shielded cables should be connected

FCC Notice “Declaration of Conformity”

This equipment has been tested and found to comply with the limits for a Class B digital device, pursuant to part 15 of the FCC Rules. These limits are designed to provide reasonable protection against harmful interference in a residential installation. This equipment generates, uses and can radiate radio frequency energy and, if not installed and used in accordance with the instructions, may cause harmful interference to radio communications. However, there is no guarantee that interference will not occur in a particular installation. If this equipment does cause harmful interference to radio or television reception, which can be determined by turning the equipment off and on, the user is encouraged to try to correct the interference by one or more of the following measures:

- Reorient or relocate the receiving antenna
- Increase the separation between the equipment and receiver
- Connect the equipment into an outlet on a circuit different from that to which the receiver is connected
- Consult the dealer or an experienced radio/TV technician for help.



Only peripherals complying with the FCC class B limits may be attached to this equipment. Operation with non-compliant peripherals or peripherals not recommended by Toshiba is likely to result in interference to radio and TV reception. Shielded cables must be used between the external devices and the computer's USB ports, external monitor port, PS/2 keyboard port and PS/2 mouse port. Changes or modifications made to this equipment, not expressly approved by Toshiba or parties authorized by Toshiba could void the user's authority to operate the equipment.

This device complies with part 15 of the FCC Rules. Operation is subject to the following two conditions:

- 1 This device may not cause harmful interference
- 2 This device must accept any interference received, including interference that may cause undesired operation.

Canadian Regulatory Information (Canada Only)

This digital apparatus does not exceed the Class B limits for radio noise emissions from digital apparatus as set out in the Radio Interference Regulation of the Canadian Department of Communications.

Note that Canadian Department of Communications (DOC) regulations provide, that changes or modifications not expressly approved by TOSHIBA Corporation could void your authority to operate this equipment.

This Class B digital apparatus meets all requirements of the Canadian Interference-Causing Equipment Regulations.

Cet appareil numérique de la class B respecte toutes les exigences du Règlement sur le matériel brouilleur du Canada.

FCC Class B Digital Devices & Peripheral Devices (Declaration of Conformity or Certification Authorization)

Declaration of Conformity Label & Marking Requirements

User Manual must provide user information in accordance with
±15.19(a)(3), 15.21, 15.27 and 15.105(b):

Instruction Manual Federal Communication Commission Interference Statement

This equipment has been tested and found to comply with the limits for a Class B digital device, pursuant to Part 15 of the FCC Rules. These limits are designed to provide reasonable protection against harmful interference in a residential installation. This equipment generates, uses and can radiate radio frequency energy and, if not installed and used in accordance with the instructions, may cause harmful interference to radio communications. However, there is no guarantee that interference will not occur in a particular installation. If this equipment does cause harmful interference to radio or television reception, which can be determined by turning the equipment off and on, the user is encouraged to try to correct the interference by one of the following measures:

- Reorient or relocate the receiving antenna
- Increase the separation between the equipment and receiver
- Connect the equipment into an outlet on a circuit different from that to which the receiver is connected
- Consult the dealer or an experienced radio/TV technician for help.

FCC Caution: Assure continued compliance (for example, use only shielded interface cables when connecting to computer or peripheral devices). Any changes or modifications not expressly approved by the manufacturer of this device could void the user's authority to operate this equipment.

This device complies with Part 15 of the FCC Rules. Operation is subject to the following two conditions: (1) This device may not cause harmful interference, and (2) this device must accept any interference received, including interference that may cause undesired operation.

Responsible Party: (Name)

(Address In U.S.A.)

Telephone No: (1-800 number located in U.S.A.)

Table of Contents

Chapter 1 Getting Started

Welcome.....	1-1
Where to Find Information	1-2

Chapter 2 Basic Skills

Parts Names and Function	2-1
Battery Charging	2-5
Initial Setup	2-7
Method of Setting Card into SD Card Slot	2-8
Connecting to a Computer	2-9
Today Screen	2-12
Programs.....	2-14
Navigation Bar and Command Bar	2-15
Pop-up Menus	2-16
Notifications.....	2-16
Enter Information on Your Toshiba Pocket PC.....	2-17
Find and Organize Information.....	2-26
Customize Your Toshiba Pocket PC.....	2-27

Chapter 3 Microsoft ActiveSync

Chapter 4 Microsoft Pocket Outlook

Calendar: Scheduling Appointments and Meetings	4-2
Contacts: Tracking Friends and Colleagues	4-5
Tasks: Keeping a To Do List.....	4-8
Notes: Capturing Thoughts and Ideas.....	4-11
Inbox: Sending and Receiving E-mail Messages	4-12

Chapter 5 Companion Programs

Pocket Word	5-1
Pocket Excel	5-6
MSN Messenger	5-7
Windows Media Player	5-11
Microsoft Reader	5-12

Chapter 6 Pocket Internet Explorer

The Mobile Favorites Folder	6-1
Favorite Links	6-1
Mobile Favorites	6-2
Using AvantGo Channels	6-3
Using Pocket Internet Explorer	6-3

Chapter 7 Getting Connected

Transfer Items Using Infrared	7-1
Get Help on Connecting.....	7-2

Chapter 8 Optional Functions

Home	8-1
Home Help.....	8-6
How to Make a Backup.....	8-10
Carrying Out Restore Operation	8-12
Data Backup Help.....	8-13

Chapter 9 Additional Information

Troubleshooting.....	9-1
Resetting	9-3
Initializing	9-3
Specifications	9-4

Getting Started

Welcome

Congratulations on purchasing your Toshiba Pocket PC. Due to the size and capabilities of this device, you can keep your most important business and personal information up-to-date and close at hand. Microsoft® ActiveSync® increases the power of your device by allowing you to synchronize the information on your desktop or laptop computer with your device. Picture yourself in the following situations:

- While walking with a colleague, your cell phone rings and your manager asks if you two are free this afternoon for an emergency meeting. While your colleague fumbles through his paper organizer, you press a button on your device and instantly see a list of today's appointments and meetings. You are quickly able to tell your manager your available times. For more information on scheduling appointments and meetings, see Chapter 4.
- You're meeting your friends tonight for dinner and a movie. You download the latest movie information from the Internet to your desktop computer and then synchronize it with your device. At dinner, you pull out your Toshiba Pocket PC device and review your movie options with your friends. For more information on downloading Web pages to your device, see Chapter 6.
- A Calendar reminder alerts you that it is time to catch the bus. You grab your Toshiba Pocket PC device and catch the bus just in time. Because ActiveSync keeps the information on your device up-to-date, you leisurely review your task list, make notes about the new books and CDs you want to buy, and read and respond to e-mail messages. When you get back to the office, ActiveSync transfers any task changes you made, your notes, and your e-mail message responses to your desktop computer. For more information on ActiveSync, see Chapter 3.

Where to Find Information

This book describes your Pocket PC's hardware, provides an overview of the programs on your Pocket PC, and explains how to connect your Pocket PC to a computer. For instructions on setting up your Pocket PC and installing ActiveSync, see the Quick Start Card. The following table is a guide to additional information to help you use your Pocket PC.

For information on:	See this source:
Programs on your Pocket PC	This User's Manual and device Help. To view Help, tap  and then Help .
Additional programs that can be installed on the Pocket PC	The Toshiba Pocket PC Companion CD.
Connecting to and synchronizing with a computer	The Quick Start Card or ActiveSync Help on your computer. To view Help, click Help and then Microsoft ActiveSync Help .
Last-minute updates and detailed technical information	The Read Me files, located in the Microsoft ActiveSync folder on the Toshiba Pocket PC computer and on the Toshiba Pocket PC Companion CD.
Up-to-date information on your Toshiba Pocket PC	http://www.pda.toshiba.com

Basic Skills

You can easily learn to use your Toshiba Pocket PC. This chapter describes the use and customization of your Toshiba Pocket PC.

Parts Names and Function



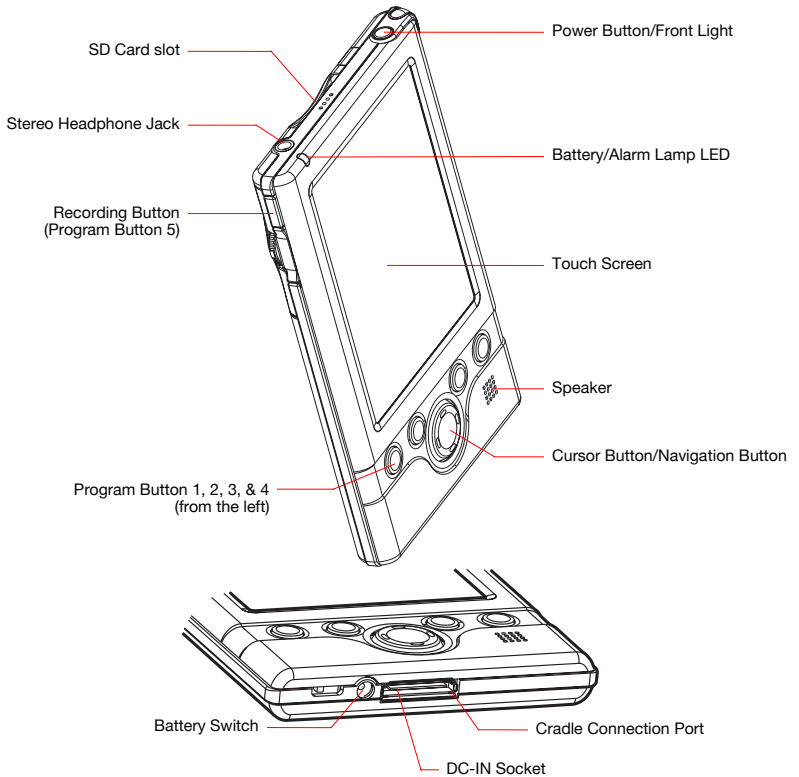

Main unit (front view)

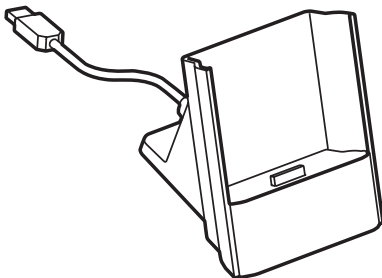

The Cradle



Initial Setting of Program Button

- Program button 1 = Calendar 
- Program button 2 = Tasks 
- Program button 3 = Home 
- Program button 4 = Contacts 
- Program button 5 = Voice recorder

Main unit (back view)

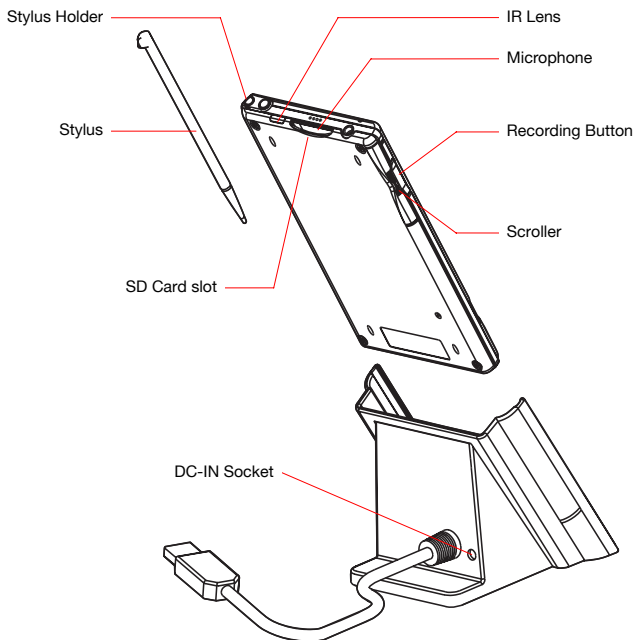

Power Button

The power button turns the unit and the front light on and off.

Power button	When the power is off	When the power is on
Press and hold it.	The power turns on.	The front light alternately turns on/off.
Press it quickly.	The power turns on.	The power turns off.

Battery Switch

The battery switch supplies/cuts off the battery power to the Toshiba Pocket PC.

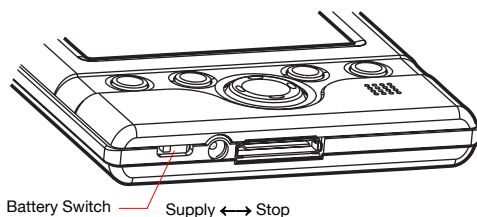

The setting of this switch at shipment is “stop”. When using the Toshiba Pocket PC for the first time, slide this switch to the left (the “supply” side) with the stylus.



Switching the battery switch to the “stop” position at any time will lead to loss of data.

Alarm Lamp LED

The alarm lamp indicates the machine condition.

Flashing orange	When the preset alarm time, which was set through Calendar or Tasks , goes off, the lamp flashes.
Glow orange	Indicates charging of the built-in battery.
Glow yellow	The built-in battery charging process is stopped due to the ambient temperature being too high or low. Charge the built-in battery in an ambient temperature of approx. 5°C to 35°C.
Glow green	Indicates full charge of the built-in battery.

How to Use the Stylus

The stylus is used for menu selection or data input on the touch-screen of the Toshiba Pocket PC.

- **Tap:** Touch the screen once with the stylus to open items and select options.
- **Drag:** Hold the stylus on the screen and drag it across to select text and images. Drag in a list to select multiple items.
- **Tap and hold:** Tap and hold the stylus on an item to see a list of actions available for that item. On the pop-up menu that appears, tap the action you want to perform.



When you operate the touch screen of the Toshiba Pocket PC, use the supplied stylus.

If the tip of the stylus is damaged, do not use it. If you operate the touch screen with a damaged stylus or a ballpoint pen, the touch screen may be damaged.

When the stylus is damaged, please purchase a new one.

About the Cursor Button

You can move a cursor (selection display) on the screen by pressing the upper, lower, right or left part of the cursor button.

You can select a program to launch by pressing the center part of the cursor button.

About the Scroller

You can also move the cursor on the screen by moving the scroller up and down.

You can select a program to launch by pressing the scroller.



The cursor movement is different depending on the screen. When the cursor is at the right or the left side of the screen, it may not move.

Battery Charging

A built-in battery is installed in the Toshiba Pocket PC. When using the Toshiba Pocket PC for the first time, set the battery switch to the supply side, and then charge the built-in battery with the supplied AC adapter.

How to Charge the Battery

You can use two charging methods.



Turn the unit off before connecting the AC Adapter and Pocket PC.

Method 1. Connect the supplied AC adapter and the cradle as shown in the figure below, and then insert the Toshiba Pocket PC into the cradle.

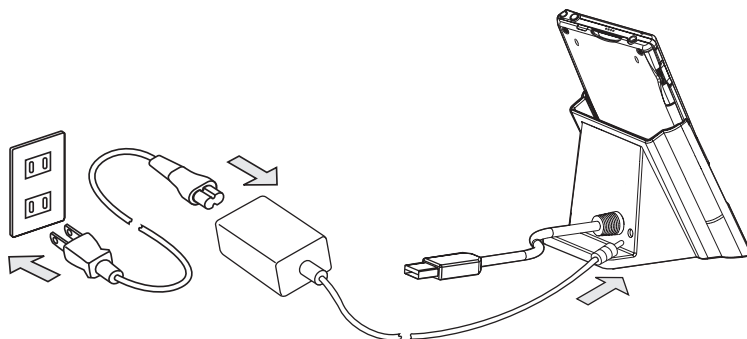

Method 2. Connect the supplied AC adapter and the Toshiba Pocket PC as shown in the figure below.

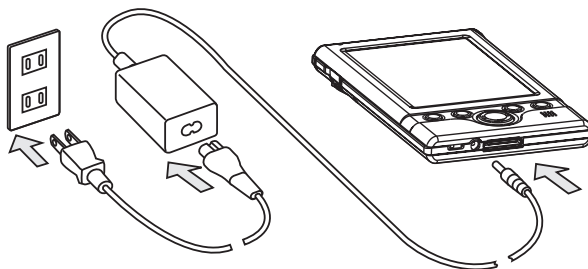

For charging the built-in battery, maintain an ambient temperature from approx. 5°C to 35°C.

When the lamp glows orange or green during the built-in battery charging, you can use the Toshiba Pocket PC.

When the built-in battery is completely charged, the Battery/Alarm lamp LED color will change to green.

How to Prolong Battery Life

- Use the Toshiba Pocket PC with the AC adapter.
When you use the Toshiba Pocket PC under the following conditions, the power consumption will be higher than normal. Please use the AC adapter when:
 - The Toshiba Pocket PC is operated while connected to your computer.
 - The Toshiba Pocket PC is operated with a storage card or with any other optional equipment.
- Select the short power-off time in the setting menu. This will shorten the time the unit will remain on if not used. For more information, see “Customize Your Toshiba Pocket PC” in this chapter.
- Turn off the front light.
- Set the screen brightness to power save mode (Med Bright or low Bright). Also shorten the light turn-off time. For more information, see “Customize Your Toshiba Pocket PC” in this chapter.
- Use the Toshiba Pocket PC with an ambient temperature between 15°C (59°F) and 25°C (77°F). This temperature range is the most effective for the built-in battery.
 - When you use the Toshiba Pocket PC in high or low temperature environments, the operable time is shortened due to the decrease of the built-in battery capacity.

Battery Life

The built-in battery has a limited life. Repeated charging/discharging of the built-in battery gradually decreases operable time.

- Do not leave the Toshiba Pocket PC in a place of high or low temperature. It may shorten battery life.



If you have not used the Toshiba Pocket PC for several days, its battery charge level reading may be inaccurate. Fully recharge the battery for 2-3 hours before using.

Battery Charge Level and Stored Data Protection

If the battery charge level becomes extremely low, or is completely discharged, the memory data stored in the Toshiba Pocket PC will be deleted.

When the low battery status icon or the alarm message appears, immediately connect the AC adapter to your Toshiba Pocket PC and charge the built-in battery.



The built-in battery gradually discharges even if the device is not being used. When the Toshiba Pocket PC is left for a long time, the built-in battery of the Toshiba Pocket PC may completely discharge.

As a precaution, it is recommended that you save the Toshiba Pocket PC's memory data to your computer or to a storage card.

The manufacturer is not responsible for data change or data loss due to battery discharge.

Initial Setup

When using the Toshiba Pocket PC for the first time, carry out the initial setup according to the procedures below after the built-in battery has been charged.

- 1 Move the battery switch to the "supply" position. The Toshiba Pocket PC powers on automatically and the Welcome screen appears. Tap the screen to start the following setup.
- 2 Execute touch screen alignment.

When the alignment screen appears, tap the center of the cross target with the stylus. The next target position changes upon tapping the target. Five taps completes the positioning alignment. The screen then changes to the Stylus screen.

 - If a finger or any other object besides the stylus touches the screen during alignment, the alignment will be cancelled and you must repeat the procedure.
- 3 Read how to use the stylus.
 - Read and understand the stylus operation, and then tap **NEXT**.



For more information on stylus operation, see "How to Use the Stylus" in this chapter.

- 4 Learn the pop-up menu operation.
 - Read the on-screen explanation and then follow the instructions. Display the pop-up menu, and cut and paste the data according to the screen instructions.
 - After you finish the paste operation, this stage is completed. Tap **NEXT**.

- 5 Set the TIME ZONE.
 - When tapping the right ▼ mark, the city and the time zone list appears. Tap the desired city and time zone.
 - When the setup is completed, tap **NEXT**.
- 6 Complete the initial setup.
 - When the Complete screen appears, the initial setup is completed.
 - After tapping the screen, you can use the Toshiba Pocket PC.



When you tap the Complete screen, the Today screen appears. For more information, see "Today screen" in this chapter.

Method of Setting Card into SD Card Slot

To insert a card:

Turn off the power. Insert the card with its contact surface (metal contact surface) facing the back of the Toshiba Pocket PC.

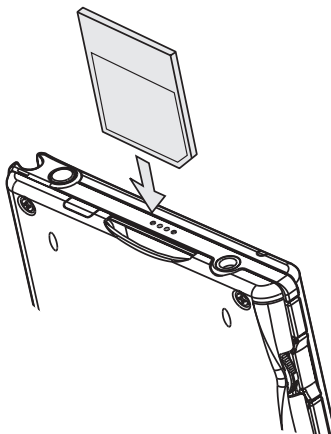

To remove a card:

- 1 Turn off the power.
- 2 Lightly press down the card until a clicking sound is heard. The card will pop out slightly from the slot.
- 3 Pull the card straight up to remove.

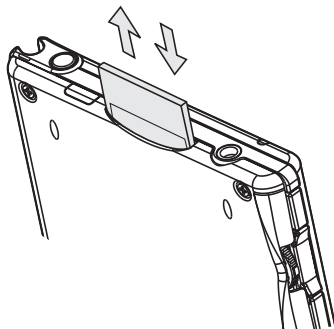
**Connecting a Remote Control-Fitted Earphone**

You can listen to the sound output from your PocketPC by connecting the optional remote control-fitted earphone microphone.

Insert the remote control-fitted earphone plug into the stereo headphone jack.



Use the specified remote control-fitted earphone. If you use a different type of earphone, it may result malfunction.

The connectable pin size of the headphone/earphone is $\phi 3.5$ mm mini plug type.

Connecting to a Computer

Before connecting your Toshiba Pocket PC to a computer, check the following.

- ActiveSync has been installed on your computer. (See Chapter 3.)
- Make sure that the Pocket PC and your computer are both turned off.
- The position of connecting port on the computer may differ according to the computer type.

To Connect Using The Supplied Cradle:

- 1 Connect the Client cradle to your computer as shown in the illustration below.

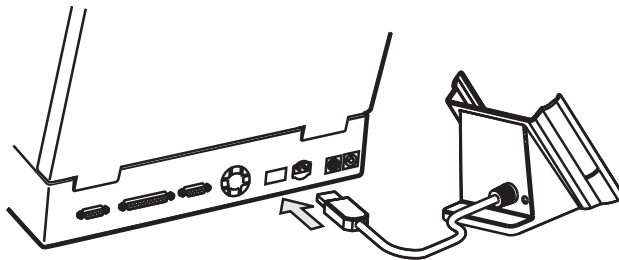

- 2 Insert the Pocket PC into the cradle.

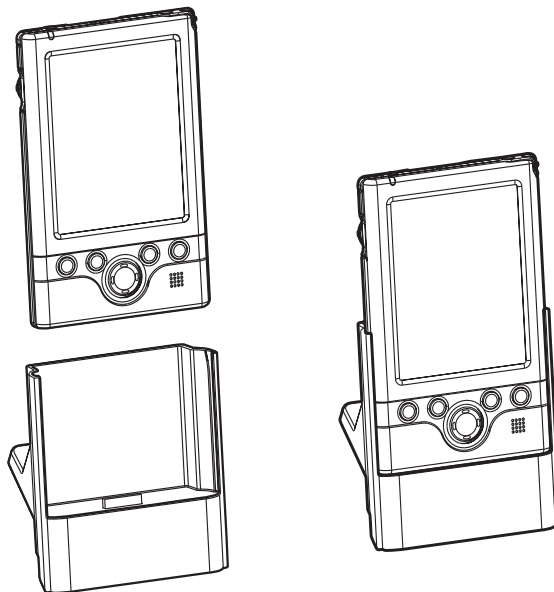

To connect directly using a connection cable:

Connect the Pocket PC directly to your computer using an optional USB Client cable.

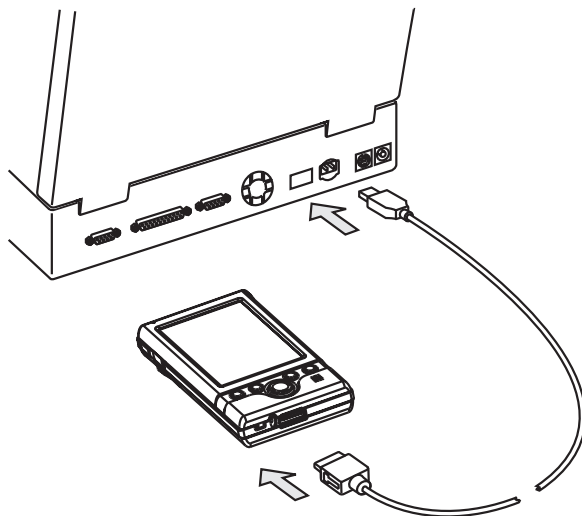

When the Pocket PC is connected to another device via a USB Client cable do not plug the AC adapter directly into the Pocket PC as this may lead to interference. Instead, plug the AC adapter into the port on the USB Client cable connector.







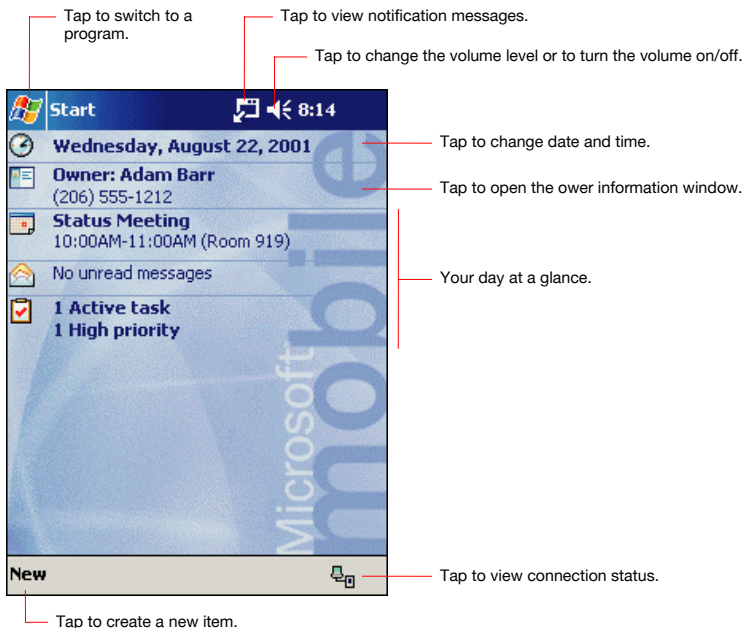



Today Screen

When you turn on your device for the first time each day (or after 4 hours of inactivity), you'll see the Today screen. You can also display it by tapping  and then **Today**. On the Today screen, you can see at a glance important information for the day.

Following are some of the status icons you may see.





Following are some of the status icons you may see.

Status Icon	Meaning
	Turns all sounds on and off
	Backup battery is low
	Main batteries are charging
	Main batteries are low
	Main batteries are very low
	Main batteries are full
	Connection is active
	Synchronization is beginning or ending
	Synchronization is occurring
	Notification that one or more instant messages were received
	Notification that one or more e-mail messages were received



If more notification icons need to be displayed then there is room to display them, the Notification icon, , will display. Tap the icon to view all notification icons.

Programs











You can switch from one program to another by selecting it from the  menu. (You can customize which programs you see on this menu. For information, see “Adjusting Settings,” later in this chapter.) To access some programs, you’ll need to tap , **Programs**, and then the program name.

You can also switch to some programs by pressing a program button. Your device has one or more program buttons located on the front or side of the device. The icons on the buttons identify the programs they switch to.



Some programs have abbreviated labels for check boxes and drop-down menus. To see the full spelling of an abbreviated label, tap and hold the stylus on the label. Drag the stylus off the label so that the command is not carried out.

The following table contains a partial list of programs that are on your device. Look on the Toshiba Pocket PC Companion CD for additional programs that you can install onto your device.

Icon	Program	Description
	ActiveSync	Synchronize information between your Pocket PC and desktop computer.
	Calendar	Keep track of your appointments and create meeting requests.
	Contacts	Keep track of your friends and colleagues.
	Inbox	Send and receive e-mail messages.
	Pocket Internet Explorer	Browse Web and WAP sites, and download new programs and files from the Internet.
	Notes	Create handwritten or typed notes, drawings, and recordings.
	Tasks	Keep track of your tasks.
	Pocket Excel	Create Excel spreadsheet or view and edit Excel spreadsheet created on your desktop computer.
	MSN Messenger	Send and receive instant messages with your MSN Messenger contacts.
	Pocket Word	Create new documents or view and edit Word documents created on your desktop computer.

Navigation Bar and Command Bar

The navigation bar is located at the top of the screen. It displays the active program and current time, and allows you to switch to programs and close screens.

Use the command bar at the bottom of the screen to perform tasks in programs. The command bar includes menu names, buttons, and the Input Panel button. To create a new item in the current program, tap **New**. To see the name of a button, tap and hold the stylus on the button. Drag the stylus off the button so that the command is not carried out.

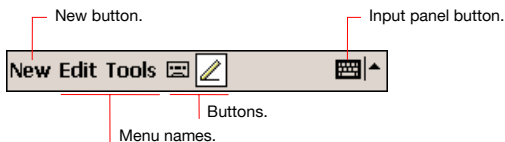
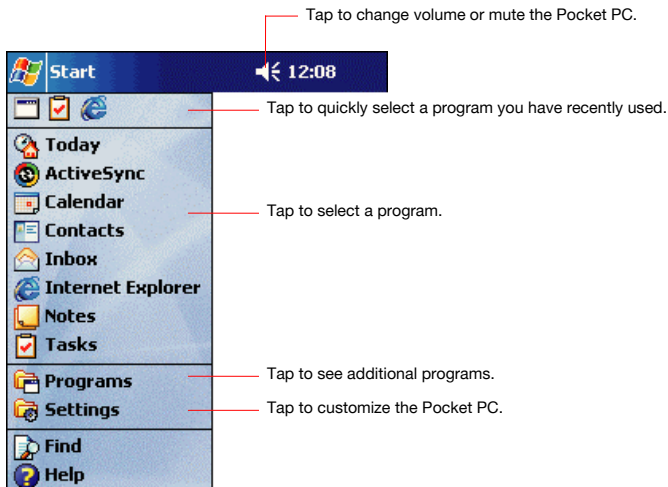

Pop-up Menus

With pop-up menus, you can quickly choose an action. For example, you can use the pop-up menu in the contact list to quickly delete a contact, make a copy of a contact, or send an e-mail message to a contact. The actions in the pop-up menus vary from program to program. To access a pop-up menu, tap and hold the stylus on the item name that you want to perform the action on. When the menu appears, lift the stylus, and tap the action you want to perform. To close the menu without performing an action, tap anywhere outside the menu.

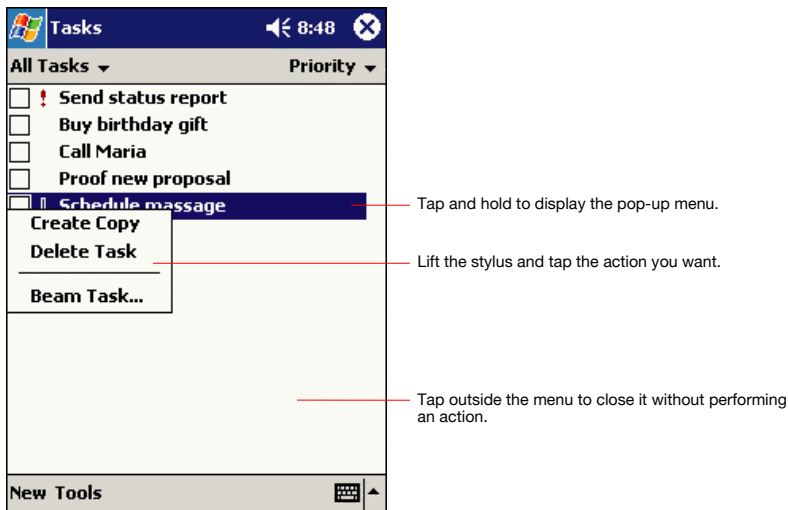

Notifications

Your device reminds you in a variety of ways when you have something to do. For example, if you've set up an appointment in Calendar, a task with a due date in Tasks, or an alarm in Clock, you'll be notified in any of the following ways:

- A message box appears on the screen
- A sound, which you can specify, is played
- A light flashes on your device

To choose reminder types and sounds for your device, tap  and then **Settings**. In the **Personal** tab, tap **Sounds & Notifications**. The options you choose here apply throughout the device.

Enter Information on Your Toshiba Pocket PC

You have several options for entering new information:

- Use the input panel to enter typed text, either by using the soft keyboard or other input method
- Write directly on the screen
- Draw pictures on the screen
- Speak into your device microphone to record a message
- Use Microsoft® ActiveSync® to synchronize or copy information from your desktop computer to your device. For more information on ActiveSync, see ActiveSync Help on your desktop computer.

Entering Text Using the Input Panel

Use the input panel to enter information in any program on your device.

You can either type using the soft keyboard or write using Letter Recognizer, Block Recognizer, or Transcriber. In either case, the characters appear as typed text on the screen.

To show or hide the input panel, tap the Input Panel button. Tap the arrow next to the Input Panel button to see your choices.

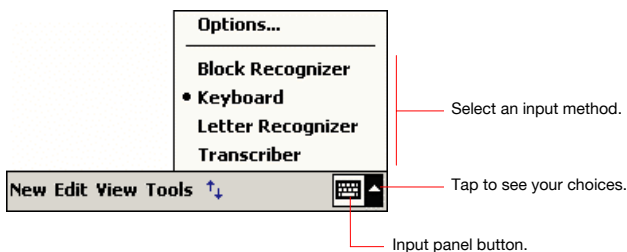

When you use the input panel, your device anticipates the word you are typing or writing and displays it above the input panel. When you tap the displayed word, it is inserted into your text at the insertion point. The more you use your device, the more words it learns to anticipate.



To change word suggestion options, such as the number of words suggested at one time, tap  **Settings, Personal tab, Input, and then the Word Completion tab.**

To type with the soft keyboard:

- 1 Tap the arrow next to the Input Panel button and then **Keyboard**.
- 2 On the soft keyboard that is displayed, tap the keys with your stylus.

To use Letter Recognizer:

With Letter Recognizer you can write letters using the stylus just as you would on paper.

- 1 Tap the arrow next to the Input Panel button and then **Letter Recognizer**.
- 2 Write a letter in the box.

When you write a letter, it is converted to typed text that appears on the screen. For specific instructions on using Letter Recognizer, with Letter Recognizer open, tap the question mark next to the writing area.

To use Block Recognizer:

With Block Recognizer you can input character strokes using the stylus that are similar to those used on other devices.

- 1 Tap the arrow next to the Input Panel button and then **Block Recognizer**.
- 2 Write a letter in the box.

When you write a letter, it is converted to typed text that appears on the screen. For specific instructions on using Block Recognizer, with Block Recognizer open, tap the question mark next to the writing area.

To use Transcriber:

With Transcriber you can write anywhere on the screen using the stylus just as you would on paper. Unlike Letter Recognizer and Block Recognizer, you can write a sentence or more of information. Then, pause and let Transcriber change the written characters to typed characters.

- 1 Tap the arrow next to the Input Panel button and then **Transcriber**.
- 2 Write anywhere on the screen.

For specific instructions on using Transcriber, with Transcriber open, tap the question mark in the lower right hand corner of the screen.

To select typed text:

If you want to edit or format typed text, you must select it first.

- Drag the stylus across the text you want to select.

You can cut, copy, and paste text by tapping and holding the selected words and then tapping an editing command on the pop-up menu, or by tapping the command on the **Edit** menu.

Writing on the Screen

In any program that accepts writing, such as the **Notes** program, and in the Notes tab in Calendar, Contacts, and Tasks, you can use your stylus to write directly on the screen. Write the way you do on paper. You can edit and format what you've written and convert the information to text at a later time.

To write on the screen:

- Tap the Pen button to switch to writing mode. This action displays lines on the screen to help you write.

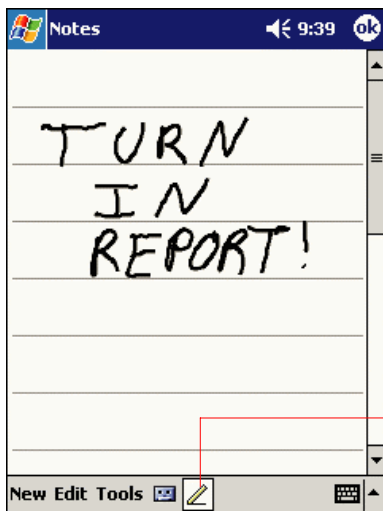

Tap the Pen button and use your stylus like a pen.



Some programs that accept writing may not have the Pen button. See the documentation for that program to find out how to switch to writing mode.

To select writing:

If you want to edit or format writing, you must select it first.

- 1 Tap and hold the stylus next to the text you want to select until the insertion point appears.
- 2 Without lifting, drag the stylus across the text you want to select.

If you accidentally write on the screen, tap **Tools**, then **Undo** and try again. You can also select text by tapping the Pen button to deselect it and then dragging the stylus across the screen.

You can cut, copy, and paste written text in the same way you work with typed text: tap and hold the selected words and then tap an editing command on the pop-up menu, or tap the command on the **Edit** menu.

To convert writing to text:

- Tap **Tools** and then **Recognize**.

If you want to convert only certain words, select them before tapping **Recognize** on the **Tools** menu (or tap and hold the selected words and then tap **Recognize** on the pop-up menu). If a word is not recognized, it is left as writing.

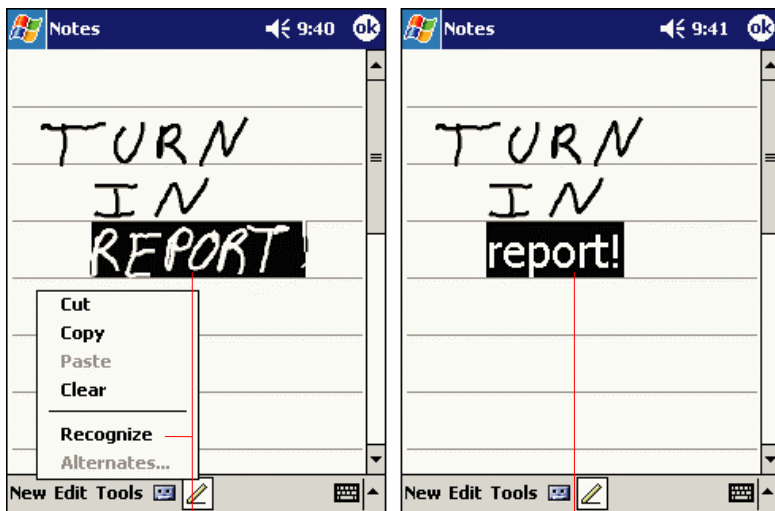

Select the text you want to convert and Tap **Recognize** on the pop-up menu.

The writing is turned into text.

If the conversion is incorrect, you can select different words from a list of alternates or return to the original writing. To do so, tap and hold the incorrect word (tap one word at a time). On the pop-up menu, tap **Alternates**. A menu with a list of alternate words appears. Tap the word you want to use, or tap the writing at the top of the menu to return to the original writing.

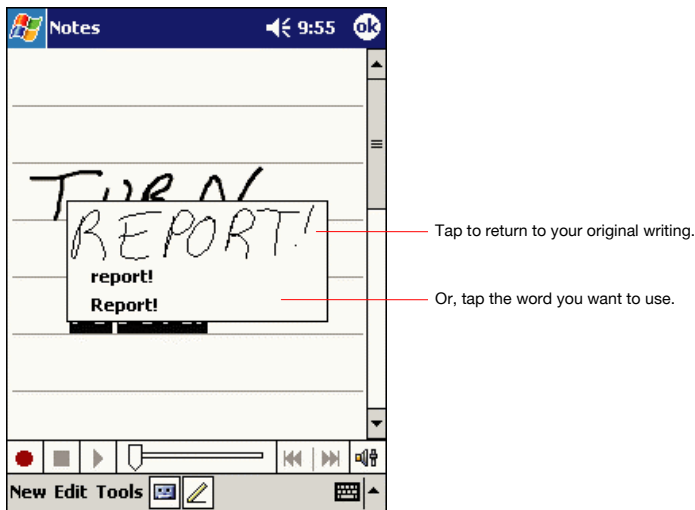

Tips for getting good recognition:

- Write neatly.
- Write on the lines and draw descenders below the line. Write the cross of the “t” and apostrophes below the top line so that they are not confused with the word above. Write periods and commas above the line.
- For better recognition, try increasing the zoom level to 300% using the **Tools** menu.
- Write the letters of a word closely and leave big gaps between words so that the device can easily tell where words begin and end.
- Hyphenated words, foreign words that use special characters such as accents, and some punctuation cannot be converted.
- If you add writing to a word to change it (such as changing a “3” to an “8”) after you attempt to recognize the word, the writing you add will not be included if you attempt to recognize the writing again.

Drawing on the Screen

You can draw on the screen in the same way that you write on the screen. The difference between writing and drawing on the screen is how you select items and how they can be edited. For example, selected drawings can be resized, while writing cannot.

To create a drawing

- Cross three ruled lines on your first stroke. A drawing box appears. Subsequent strokes in or touching the drawing box become part of the drawing. Drawings that do not cross three ruled lines will be treated as writing.

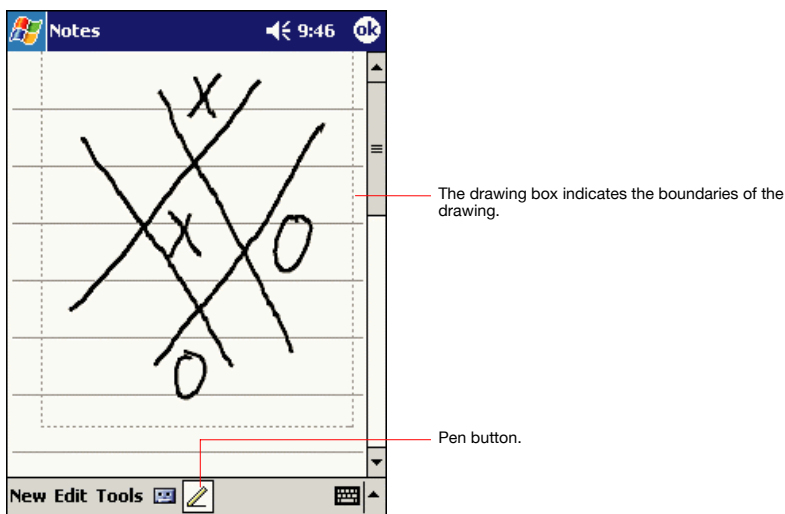

You may want to change the zoom level so that you can more easily work on or view your drawing. Tap **Tools** and then a zoom level.

To select a drawing

If you want to edit or format a drawing, you must select it first.

- Tap and hold the stylus on the drawing until the selection handle appears. To select multiple drawings, deselect the Pen button and then drag to select the drawings you want.

You can cut, copy, and paste selected drawings by tapping and holding the selected drawing and then tapping an editing command on the popup menu, or by tapping the command on the **Edit** menu. To resize a drawing, make sure the Pen button is not selected, and drag a selection handle.

Recording a Message

In any program where you can write or draw on the screen, you can also quickly capture thoughts, reminders, and phone numbers by recording a message. In Calendar, Tasks, and Contacts, you can include a recording in the **Notes** tab. In the Notes program, you can either create a standalone recording or include a recording in a written note. If you want to include the recording in a note, open the note first. In the Inbox program, you can add a recording to an e-mail message.

To create a recording:

- 1 Hold your device's microphone near your mouth or other source of sound.
- 2 Press and hold the Recording button on your Pocket PC until you hear a beep.
- 3 While holding down the Recording button, make your recording.
- 4 To stop recording, release the Recording button. Two beeps will sound.

The new recording appears in the note list or as an embedded icon.



You can also make a recording by tapping the **Recording** button on the Recording toolbar.

To play a recording, tap it in the list or tap its icon in the note.

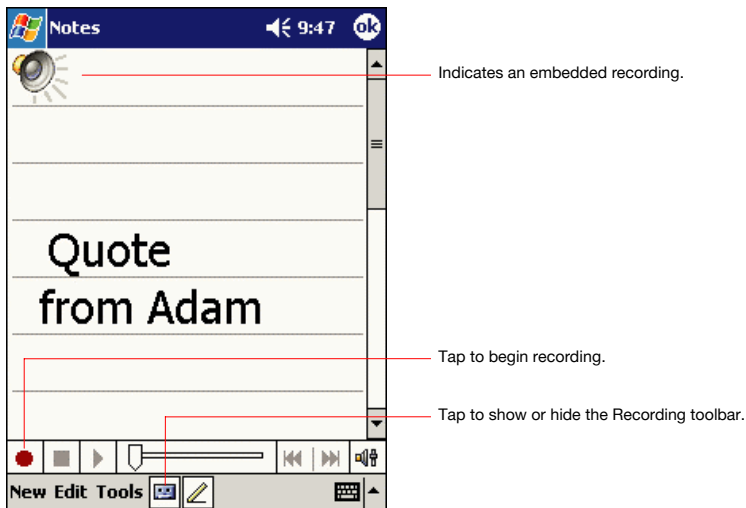

Using My Text

When using Inbox or MSN Messenger, use My Text to quickly insert preset or frequently used messages into the text entry area. To insert a message, tap **My Text** and tap a message.



You can add text after inserting a My Text message before sending it.

To edit a My Text message, in the Tools menu, tap Edit and then tap My Text Messages . Select the message you wish to edit and make desired changes.

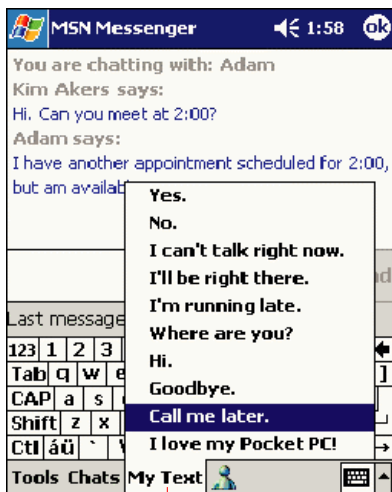

Tap to select a prewritten message.

Find and Organize Information

The Find feature on your device helps you quickly locate information.

- On the  menu, tap **Find**. Enter the text you want to find, select a data type, and then tap Go to start the search.



*To quickly find information that is taking up storage space on your Pocket PC, select **Larger than 64 KB in Type**.*

You can also use the File Explorer to find files on your device and to organize these files into folders. On the  menu, tap **Programs**, and then **File Explorer**.

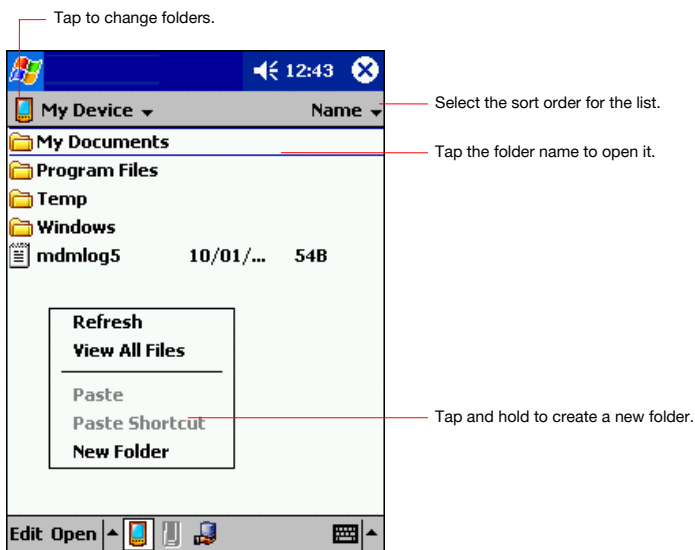

*You can move files in File Explorer by tapping and holding the item you want to move, and then tapping **Cut** or **Copy** and **Paste** on the pop-up menu.*

Customize Your Toshiba Pocket PC

You can customize your device by adjusting device settings and installing additional software.

Adjusting Settings

You can adjust device settings to suit the way you work. To see available options, tap , **Settings**, then the **Personal** or **System** tab located at the bottom of the screen.

You might want to adjust the following:

- **Clock**, to change the time or to set alarms
- **Menus**, to customize what appears on the  menu, and to enable a pop-up menu from the **New** button
- **Owner Information**, to enter your contact information
- **Password**, to limit access to your device
- **Power**, to maximize battery life
- **Today**, to customize the look and the information that is displayed on the Today screen

Adding or Removing Programs

Programs added to your device at the factory are stored in ROM (read-only memory). You cannot remove this software, and you'll never accidentally lose ROM contents. ROM programs can be updated using special installation programs with a *.xip extension. All other programs and data files added to your device after factory installation are stored in RAM (random access memory).

You can install any program created for your device, as long as your device has enough memory. The most popular place to find software for your device is on the Pocket PC Web site (<http://www.microsoft.com/mobile/pocketpc>).

To add programs using ActiveSync

You'll need to install the appropriate software for your device on your desktop computer before installing it on your device.



- 1 Determine your device and processor type so that you know which version of the software to install. Tap  and then **Settings**. On the **System** tab, tap **About**. In the **Version** tab, make a note of the information in **Processor**.
- 2 Download the program to your desktop computer (or insert the CD or disk that contains the program into your desktop computer). You may see a single *.xip, *.exe, or *.zip file, a Setup.exe file, or several versions of files for different device types and processors. Be sure to select the program designed for the Toshiba Pocket PC and your device processor type.

- 3 Read any installation instructions, Read Me files, or documentation that comes with the program.
Many programs provide special installation instructions.
- 4 Connect your device and desktop computer.
- 5 Double-click the *.exe file.
 - If the file is an installer, the installation wizard will begin. Follow the directions on the screen. Once the software has been installed on your desktop computer, the installer will automatically transfer the software to your device.
 - If the file is not an installer, you will see an error message stating that the program is valid but it is designed for a different type of computer. You will need to move this file to your device. If you cannot find any installation instructions for the program in the Read Me file or documentation, use ActiveSync Explore to copy the program file to the Program Files folder on your device. For more information on copying files using ActiveSync, see ActiveSync Help.

Once installation is complete, tap , **Programs**, and then the program icon to switch to it.

To add a program to the Start menu

Tap , **Settings, Menus**, the **Start Menu** tab, and then mark the check box for the program. If you do not see the program listed, you can either use File Explorer on the device to move the program to the Start Menu folder, or use ActiveSync on the desktop computer to create a shortcut to the program and place the shortcut in the Start Menu folder.

- **Using File Explorer on the device:** Tap , **Programs, File Explorer**, and locate the program (tap the folder list, labeled **My Documents** by default, and then **My Device** to see a list of all folders on the device). Tap and hold the program and tap **Cut** on the pop-up menu. Open the Start Menu folder located in the Windows folder, tap and hold a blank area of the window, and tap **Paste** on the pop-up menu. The program will now appear on the menu. For more information on using File Explorer, see “Find and Organize Information,” earlier in this chapter.
- **Using ActiveSync on the desktop computer:** Use the Explorer in ActiveSync to explore your device files and locate the program. Rightclick the program, and then click **Create Shortcut**. Move the shortcut to the Start Menu folder in the Windows folder. The shortcut now appears on the  menu. For more information, see ActiveSync Help.

To remove programs

- Tap , and then **Settings**. On the **System** tab, tap **Remove Programs**

If the program does not appear in the list of installed programs, use File Explorer on your device to locate the program, tap and hold the program, and then tap **Delete** on the pop-up menu.

Setting a Password

You can protect data or settings from a third person by setting a password which is requested when turning power on.

- 1 Tap  and then **Settings**. On the **Personal** tab, tap **Password**.
- 2 Select the type of password you would like to use.
- 3 Enter a password and tap **OK**.
- 4 Tap YES on the confirmation screen. The password is saved and the screen returns to the Personal tab screen



If you tap YES on the confirmation screen to return to the Personal tab screen, it becomes necessary to enter the password even for displaying the Password setting screen.

In case you forget the password, it is necessary to initialize the Pocket PC. Please note that when initialization is executed, data or settings stored in the Pocket PC are all deleted.

Setting Frontlight

You can set the screen brightness for better sight according to a place of use. You can also set the time that elapses until the front light turns off automatically after the last operation.

- 1 Tap  and then **Settings**. On the **System** tab, tap **Frontlight**.
- 2 Perform your Frontlight settings according to your needs.
- 3 When finished, tap **OK** to return to the System tab screen.

Setting Power

You can set to confirm the built-in battery remaining power and the time that elapses until the power turns off after the last operation.

- 1 Tap  and then **Settings**. On the **System** tab, tap **Power**.
- 2 Perform your Power settings according to your needs.
- 3 When finished, tap **OK** to return to the System tab screen.

Setting Memory

You can adjust the data storing memory and the program running memory. You can also confirm the free space of a storage card and so on. Memory for the Pocket PC is managed automatically.

To change Memory allocation:

- 1 Tap  and then **Settings**. On the **System** tab, tap **Memory** to display the Memory setting screen.
- 2 Drag the knob widthwise to adjust the memory allocation between Storage and Program.
- 3 When finished, tap **OK** to return to the System tab screen.

To confirm usage status of a storage card:

- 1 Tap **Storage Card** tab on the Memory setting screen.
- 2 When finished, tap **OK** to return to the System tab screen.

To release memory:

If memory is running short of its capacity, i.e., error message display, the following methods are available to release the memory.

- Transfer data to a storage card and the like and delete them from the Pocket PC.
- Delete unnecessary files.
- Quit a program in execution.
- Delete a program not in use.



For more information on detailed operation method or the memory release method other than the above, see the online help.

Microsoft ActiveSync

Using Microsoft® ActiveSync®, you can synchronize the information on your desktop computer with the information on your device. Synchronization compares the data on your device with your PC and updates both computers with the most recent information. For example:

- Keep Pocket Outlook data up-to-date by synchronizing your device with Microsoft Outlook data on your PC.
- Synchronize Microsoft Word and Microsoft Excel files between your device and desktop computer.

Your files are automatically converted to the correct format.



By default, ActiveSync does not automatically synchronize all types of information. Use ActiveSync options to turn synchronization on and off for specific information types.

With ActiveSync, you can also:

- Back up and restore your device data.
- Copy (rather than synchronize) files between your device and desktop computer.
- Control when synchronization occurs by selecting a synchronization mode. For example, you can synchronize continually while connected to your desktop computer or only when you choose the synchronize command.
- Select which information types are synchronized and control how much data is synchronized. For example, you can choose how many weeks of past appointments you want synchronized.

Before you begin synchronization, install ActiveSync on your PC from the Toshiba Pocket PC Companion CD. For more information on installing ActiveSync, see your Quick Start card. ActiveSync is already installed on your device.

After installation is complete, the ActiveSync Setup Wizard helps you connect your Pocket PC to your PC, set up a partnership so you can synchronize information between your Pocket PC and your PC, and customize your synchronization settings. Your first synchronization process will automatically begin when you finish using the wizard.

After your first synchronization, take a look at Calendar, Contacts, and Tasks on your device. You'll notice that information you've stored in Microsoft Outlook on your PC has been copied to your device, and you didn't have to type a word. Disconnect your device from your PC and you're ready to go!

Once you have set up ActiveSync and completed the first synchronization process, you can initiate synchronization from your device. To switch to ActiveSync on your device, tap , and then tap **ActiveSync**.

For information about using ActiveSync on your PC, start ActiveSync on your PC and then see ActiveSync Help.

For more information about ActiveSync on your device, switch to ActiveSync, tap , and then tap **Help**.

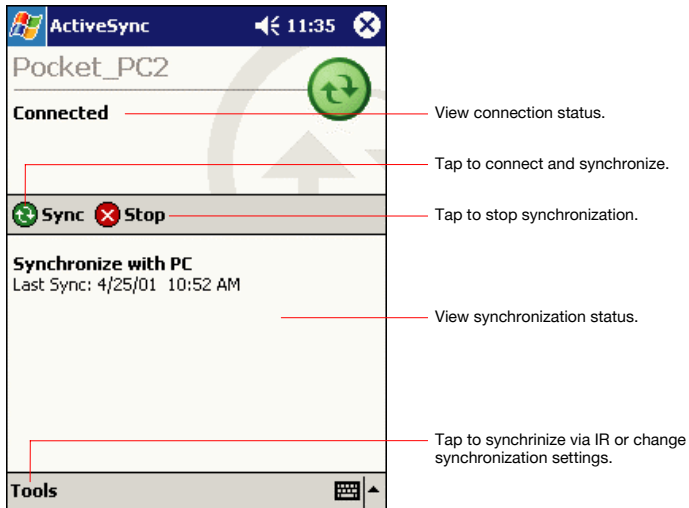

Microsoft Pocket Outlook

Microsoft® Pocket Outlook includes Calendar, Contacts, Tasks, Inbox, and Notes. You can use these programs individually or together. For example, e-mail addresses stored in Contacts can be used to address e-mail messages in Inbox.

Using ActiveSync® you can synchronize information in Microsoft Outlook or Microsoft Exchange on your desktop computer with your device. You can also synchronize this information directly with a Microsoft Exchange server. Each time you synchronize, ActiveSync compares the changes you made on your device and desktop computer or server and updates both computers with the latest information. For information on using ActiveSync, see ActiveSync Help on the desktop computer.

You can switch to any of these programs by tapping them on the  menu.

Calendar: Scheduling Appointments and Meetings

Use Calendar to schedule appointments, including meetings and other events. You can check your appointments in one of several views (Agenda, Day, Week, Month, and Year) and easily switch views by using the **View** menu.

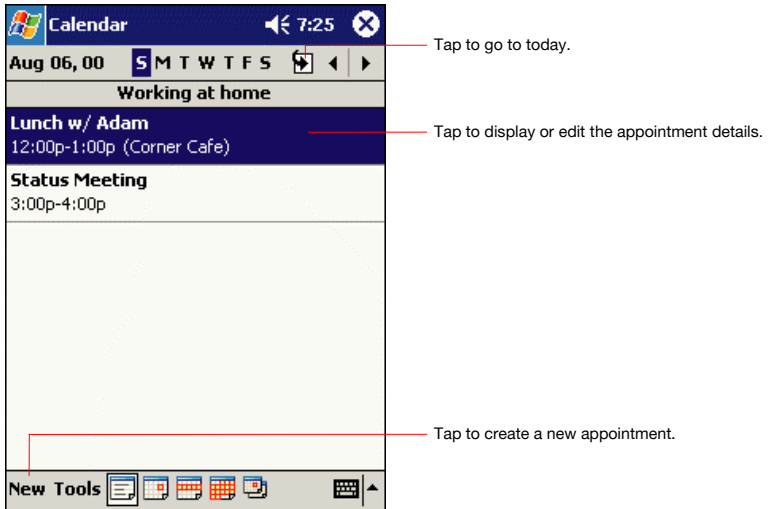

*You can customize the Calendar display, such as changing the first day of the week, by tapping **Options** on the **Tools** menu.*

To create an appointment

- 1 If you are in Day or Week view, tap the desired date and time for the appointment.
- 2 Tap **New**.

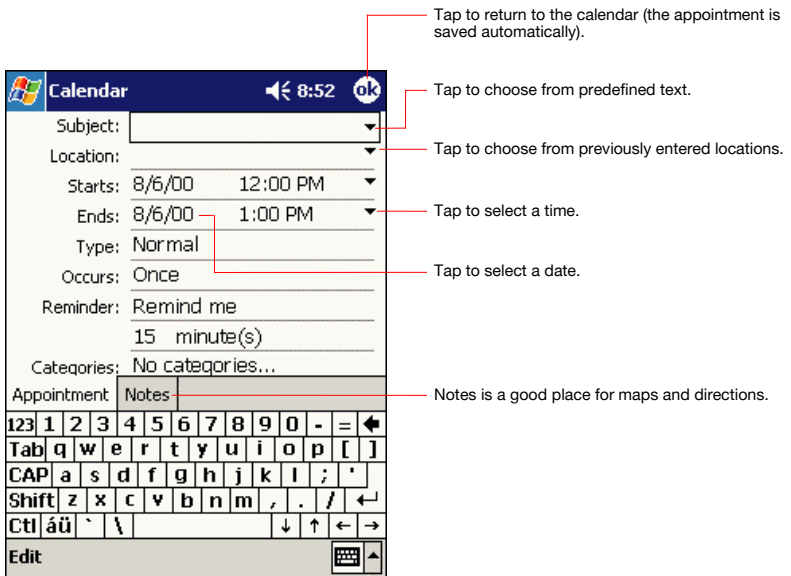

- 3 Using the input panel, enter a description and a location. Tap first to select the field.
- 4 If needed, tap the date and time to change them.
- 5 Enter other desired information. You will need to hide the input panel to see all available fields.
- 6 To add notes, tap the Notes tab. You can enter text, draw, or create a recording. For more information on creating notes, see “Notes: Capturing Thoughts and Ideas,” later in this chapter.
- 7 When finished, tap **OK** to return to the calendar.



If you select **Remind me** in an appointment, your device will remind you according to the options set in  **Settings, Personal tab, Sounds & Notifications**.

Using the Summary Screen

When you tap an appointment in Calendar, a summary screen is displayed. To change the appointment, tap **Edit**.

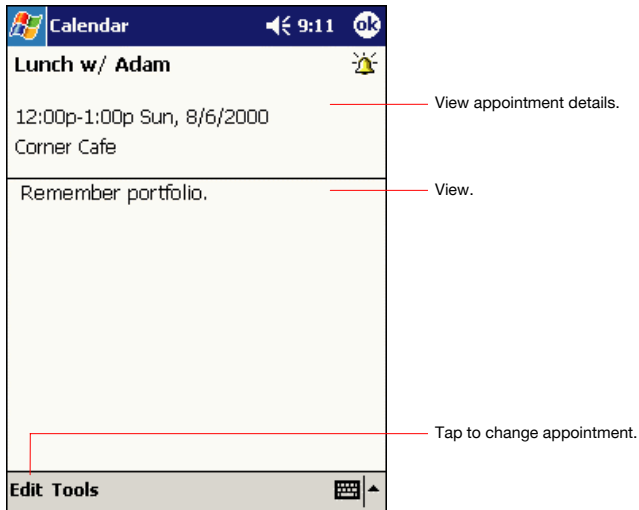

Creating Meeting Requests

You can use Calendar to set up meetings with users of Outlook or Pocket Outlook. The meeting request will be created automatically and sent either when you synchronize Inbox or when you connect to your e-mail server. Indicate how you want meeting requests sent by tapping Tools and then Options. If you send and receive e-mail messages through ActiveSync, select **ActiveSync**.

To schedule a meeting:

- 1 Create an appointment by tapping **New**.
- 2 In the appointment details, hide the input panel, and then tap **Attendees**.
- 3 From the list of e-mail addresses you've entered in Contacts, select the meeting attendees.

The meeting notice is created automatically and placed in the Outbox folder.

For more information on sending and receiving meeting requests, see Calendar Help and Inbox Help on the device.

Contacts: Tracking Friends and Colleagues

Contacts maintains a list of your friends and colleagues so that you can easily find the information you're looking for, whether you're at home or on the road. Using the device infrared (IR) port, you can quickly share Contacts information with other device users.

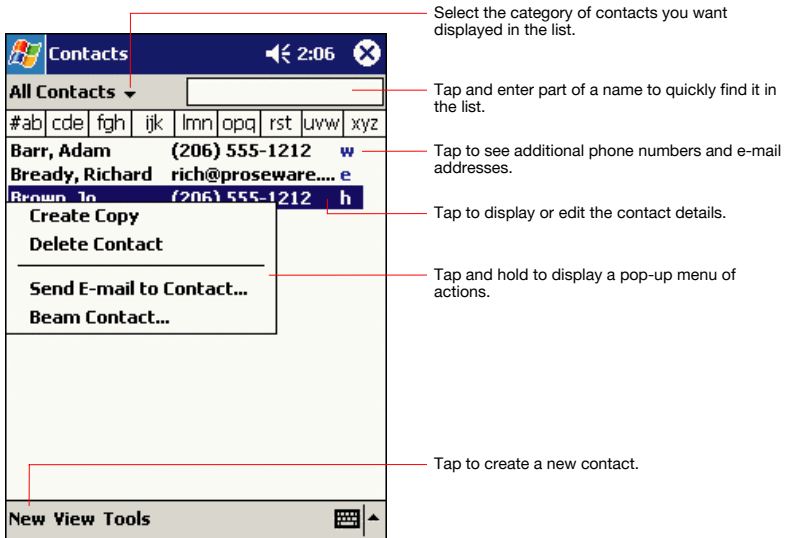

To change the way information is displayed in the list, tap **Tools** and then **Options**.

To create a contact:

1 Tap New.

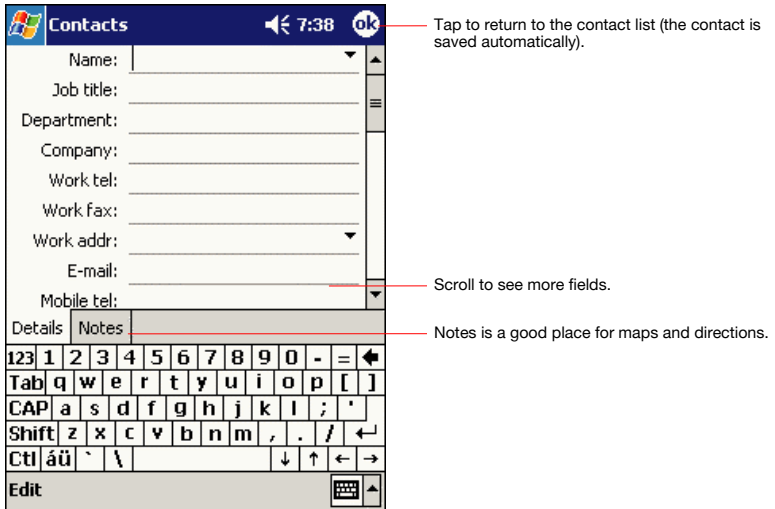

- 2 Using the input panel, enter a name and other contact information. You will need to scroll down to see all available fields.
- 3 To assign the contact to a category, scroll to and tap **Categories** and select a category from the list. In the contact list, you can display contacts by category.
- 4 To add notes, tap the **Notes** tab. You can enter text, draw, or create a recording. For more information on creating notes, see “Notes: Capturing Thoughts and Ideas,” later in this chapter.
- 5 When finished, tap **OK** to return to the contact list.

Finding a contact

There are four ways to find a contact:

- In the contact list, enter a contact name in the box under the navigation bar. To show all contacts again, clear text from the box or tap the button to the right of the box.
- In the contact list, tap the category list (labeled **All Contacts** by default) and select the type of contact that you want displayed. To show all contacts again, select **All Contacts**. To view a contact not assigned to a category, select **No Categories**.
- To view the names of companies your contacts work for, in the contact list, tap **View > By Company**. The number of contacts that work for that company will be displayed to the right of the company name.
- Tap , **Find**, enter the contact name, select **Contacts** for the type, and then tap **Go**.

Using the Summary Screen

When you tap a contact in the contact list, a summary screen is displayed. To change the contact information, tap **Edit**.

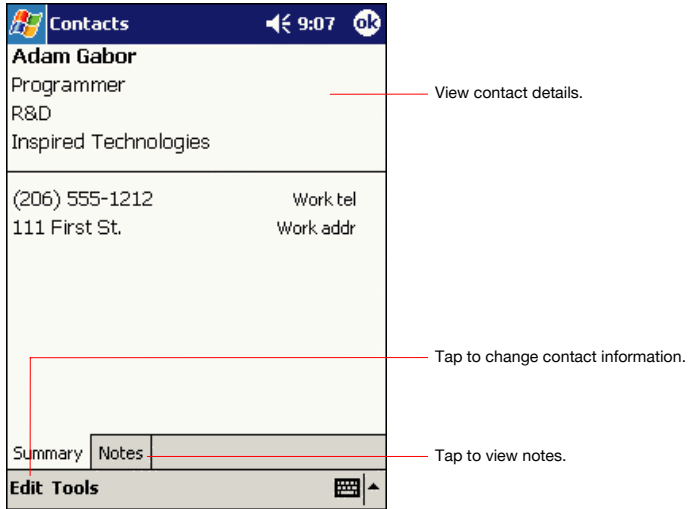

Tasks: Keeping a To Do List

Use Tasks to keep track of what you have to do.

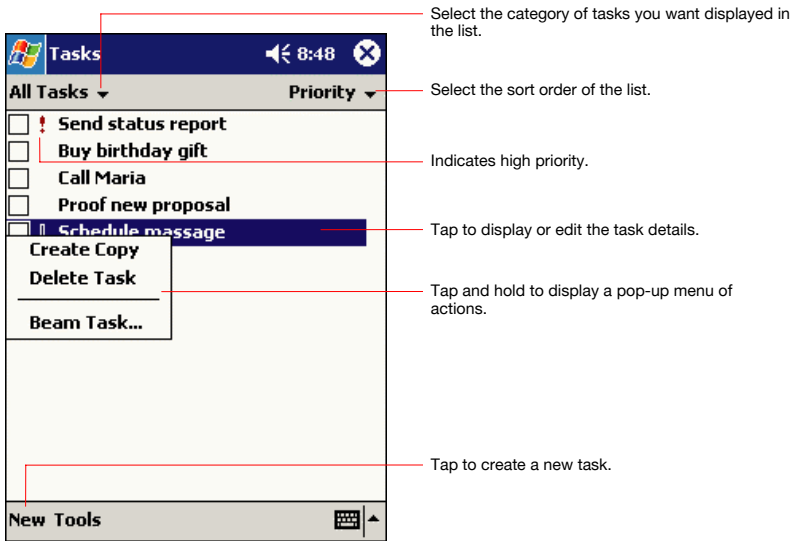

*To change the way information is displayed in the list, tap **Tools** and then **Options**.*

To create a task:

1 Tap New.

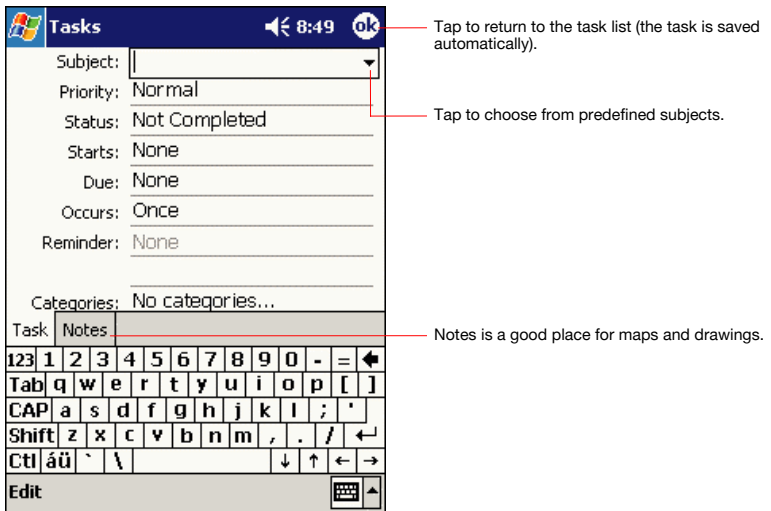

- 2 Using the input panel, enter a description.
- 3 You can enter a start date and due date or enter other information by first tapping the field. If the input panel is open, you will need to hide it to see all available fields.
- 4 To assign the task to a **category**, tap Categories and select a category from the list. In the task list, you can display tasks by category.
- 5 To add notes, tap the **Notes** tab. You can enter text, draw, or create a recording. For more information on creating notes, see “Notes: Capturing Thoughts and Ideas,” later in this chapter.
- 6 When finished, tap **OK** to return to the task list.



*To quickly create a task with only a subject, tap **Entry Bar** on the **Tools** menu. Then, tap **Tap here to add a new task** and enter your task information.*

Using the Summary Screen

When you tap a task in the task list, a summary screen is displayed. To change the task, tap **Edit**.

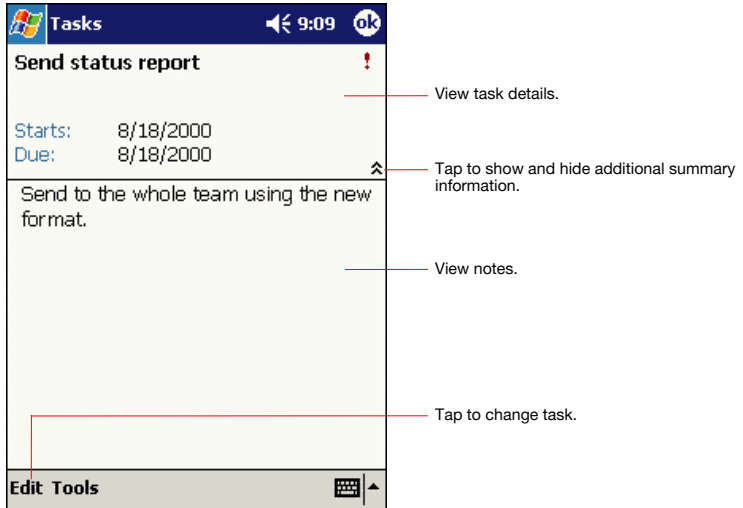

Notes: Capturing Thoughts and Ideas

Quickly capture thoughts, reminders, ideas, drawings, and phone numbers with Notes. You can create a written note or a recording. You can also include a recording in a note. If a note is open when you create the recording, it will be included in the note as an icon. If the note list is displayed, it will be created as a stand-alone recording.

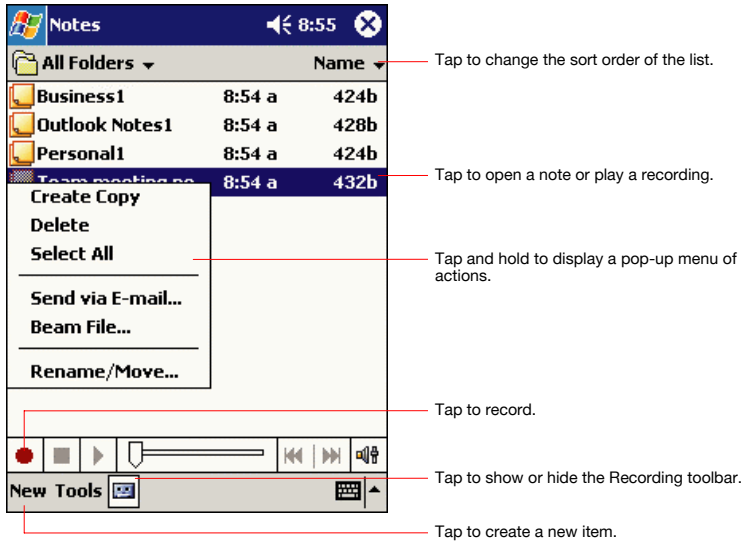

To create a note:

- 1 Tap **New**.
- 2 Create your note by writing, drawing, typing, and recording. For more information about using the input panel, writing and drawing on the screen, and creating recordings, see Chapter 2.

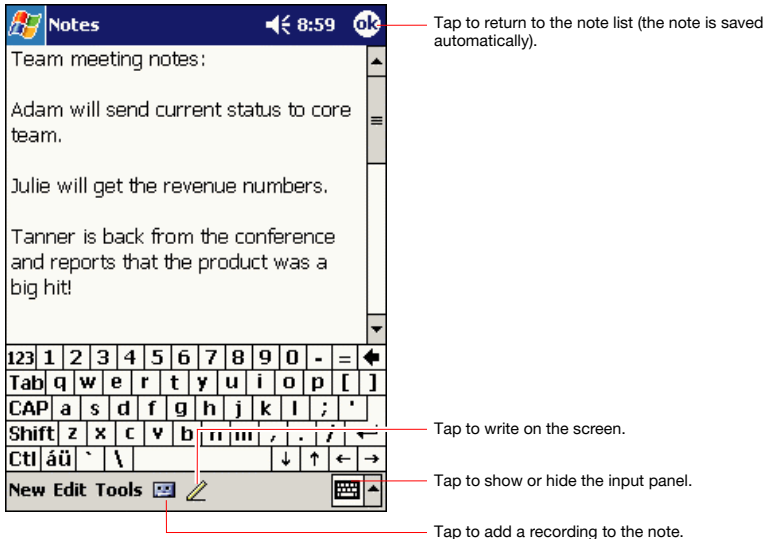

Inbox: Sending and Receiving E-mail Messages

Use Inbox to send and receive e-mail messages by synchronizing e-mail messages with Microsoft Exchange or Microsoft Outlook on your PC.

Synchronizing E-mail Messages

E-mail messages can be synchronized as part of the general synchronization process. You will need to enable Inbox synchronization in ActiveSync. For information on enabling Inbox synchronization, see ActiveSync Help on the PC.

During synchronization:

- Messages are copied from the mail folders of Exchange or Outlook on your desktop computer to the ActiveSync folder in Inbox on your device. By default, you will receive messages from the past three days only, the first 100 lines of each message, and file attachments of less than 100 KB in size.
- E-mail messages in the Outbox folder on your device are transferred to Exchange or Outlook, and then sent from those programs.
- E-mail messages in subfolders must be selected in ActiveSync on your desktop computer in order to be transferred.

Using the Message List

Messages you receive are displayed in the message list. By default, the most recently received messages are displayed first in the list.

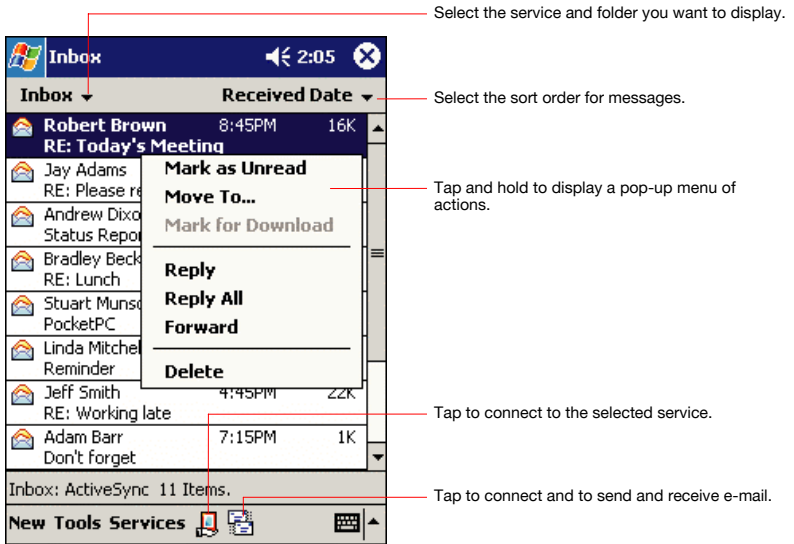

When you receive a message, tap it to open it. Unread messages are displayed in bold.

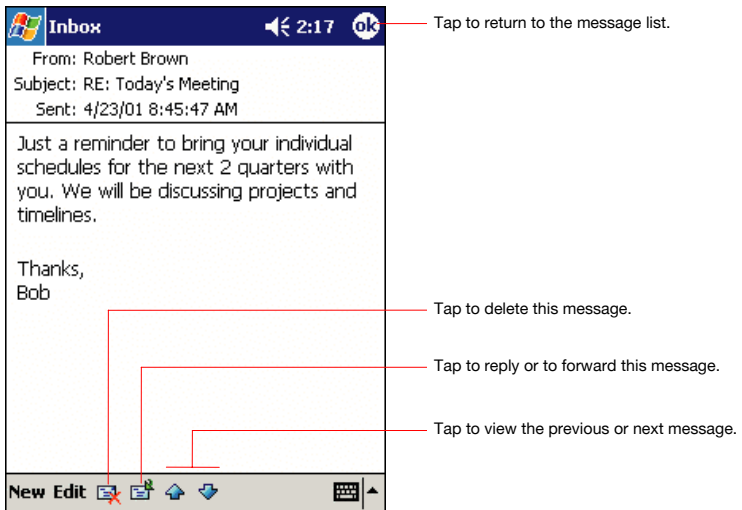

When you connect to your e-mail server or synchronize with your desktop computer, by default, you'll receive messages from the last five days only, the first 100 lines of each new message, and file attachments of less than 100 KB in size. The original messages remain on the e-mail server or your desktop computer.

You can mark the messages that you want to retrieve in full during your next synchronization or e-mail server connection. In the message list, tap and hold the message you want to retrieve. On the pop-up menu, tap **Mark for Download**. The icons in the Inbox message list give you visual indications of message status.

You specify your downloading preferences when you set up the service or select your synchronization options. You can change them at any time:

- Change options for Inbox synchronization using ActiveSync options.

For more information, see ActiveSync Help.

- Change options for direct e-mail server connections in Inbox on your device. Tap **Tools** and then tap Options. On the Service tab, tap the service you want to change. Tap and hold the service and select Delete to remove a service.

Composing Messages

To compose a message:

- 1 Tap **New**.
- 2 In the **To** field, enter an e-mail or SMS address of one or more recipients, separating them with a semicolon, or select a name from the contact list by tapping the **Address Book** button. All e-mail addresses entered in the e-mail fields in Contacts appear in the Address Book.

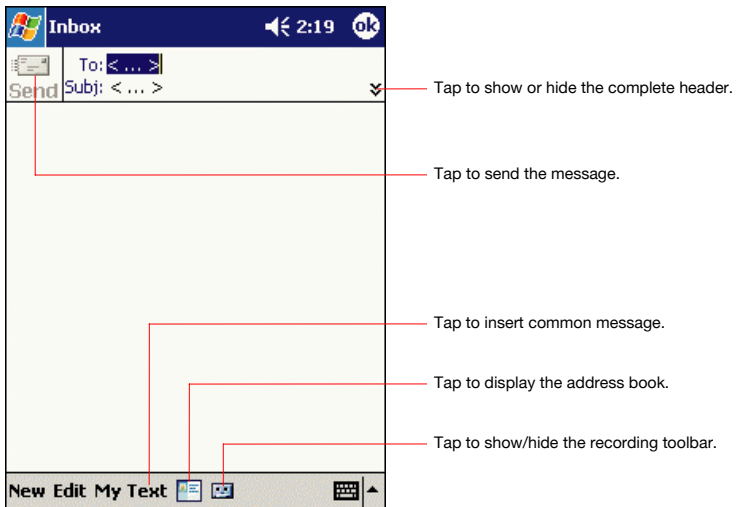

- 3 Compose your message. To enter preset or frequently used messages, tap **My Text** and select a message.
- 4 Tap **Send** when you've finished the message. If you are working offline, the message is moved to the Outbox folder and will be sent the next time you connect. If you are working online, it is sent immediately.

If you are sending an SMS message and want to know if it was received, tap **Edit**, **Options**, and select **Request SMS text message delivery notification** before sending the message.

Managing E-mail Messages and Folders

By default, messages are displayed in one of five folders for each service you have created: Inbox, Deleted Items, Drafts, Outbox, and Sent Items. The Deleted Items folder contains messages that have been deleted on the device. The behavior of the Deleted and Sent Items folders depends on the options you have chosen. In the message list, tap **Tools** and then **Options**. On the **Message** tab, select your options.

If you want to organize messages into additional folders, tap **Tools**, and then **Manage Folders** to create new folders. To move a message to another folder, in the message list, tap and hold the message and then tap **Move to** on the pop-up menu.

Folder behavior with a direct connection to an e-mail server

The behavior of the folders you create depends on whether you are using ActiveSync, SMS, POP3, or IMAP4.

- If you use ActiveSync, e-mail messages in the Inbox folder in Outlook will automatically be synchronized with your device. You can select to synchronize additional folders by designating them for ActiveSync. The folders you create and the messages you move will then be mirrored on the server. For example, if you move two messages from the Inbox folder to a folder named Family, and you have designated Family for synchronization, the server creates a copy of the Family folder and copies the messages into that folder. You can then read the messages while away from your desktop computer.
- If you use SMS, messages are stored in the Inbox folder.
- If you use POP3 and you move e-mail messages to a folder you created, the link is broken between the messages on the device and their copies on the mail server. The next time you connect, the mail server will see that the messages are missing from the device Inbox and delete them from the server. This prevents you from having duplicate copies of a message, but it also means that you will no longer have access to messages that you move to folders created from anywhere except the device.

- If you use IMAP4, the folders you create and the e-mail messages you move are mirrored on the server. Therefore, messages are available to you anytime you connect to your mail server, whether it is from your device or desktop computer. This synchronization of folders occurs whenever you connect to your mail server, create new folders, or rename/ delete folders when connected.

Companion Programs

The companion programs consist of Microsoft® Pocket Word, Microsoft® Pocket Excel, Windows Media™ Player, and Microsoft® Reader.

To switch to a companion program on your device, tap **Programs** on the  menu, and then tap the program name.

Pocket Word

Pocket Word works with Microsoft Word on your desktop computer to give you easy access to copies of your documents. You can create new documents on your device, or you can copy documents from your desktop computer to your device. Synchronize documents between your desktop computer and your device so that you have the most up-to-date content in both locations.

Use Pocket Word to create documents, such as letters, meeting minutes, and trip reports. To create a new file, tap , **Programs**, **Pocket Word**, and then **New**. A blank document appears. Or, if you've selected a template for new documents in the **Options** dialog box, that template appears with appropriate text and formatting already provided. You can open only one document at a time; when you open a second document, you'll be asked to save the first. You can save a document you create or edit in a variety of formats, including Word (.doc), Pocket Word (.psw), Rich Text Format (.rtf), and Plain Text (.txt).

Pocket Word contains a list of the files stored on your device. Tap a file in the list to open it. To delete, make copies of, and send files, tap and hold a file in the list. Then, select the appropriate action on the popup menu.

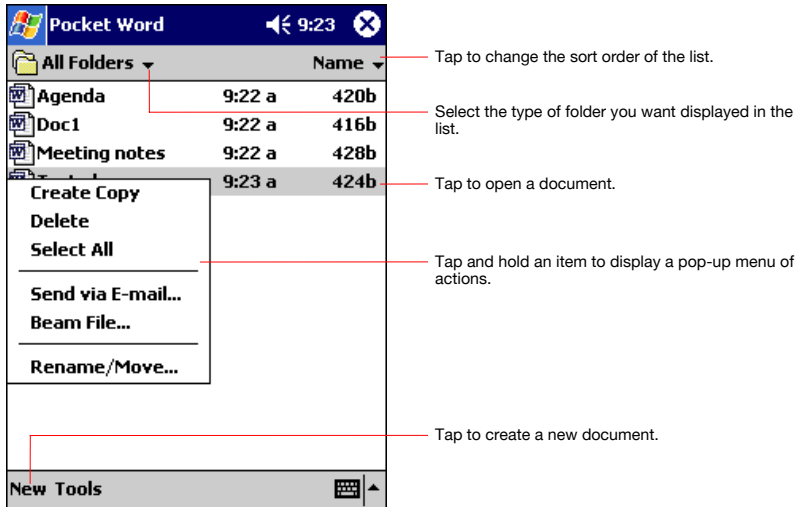

You can enter information in Pocket Word in one of four modes (typing, writing, drawing, and recording), which are displayed on the **View** menu. Each mode has its own toolbar, which you can show and hide by tapping the **Show/Hide Toolbar** button on the command bar.



*You can change the zoom magnification by tapping **View** and then **Zoom**. Then select the percentage you want. Select a higher percentage to enter text and a lower one to see more of your document.*

*If you're opening a Word document created on a desktop computer, select **Wrap to Window** on the **View** menu so that you can see the entire document.*

Typing Mode

Using the input panel, enter typed text into the document. For more information on entering typed text, see Chapter 2.

To format existing text and to edit text, first select the text. You can select text as you do in a Word document, using your stylus instead of the mouse to drag through the text you want to select. You can search a document to find text by tapping **Edit** and then **Find/Replace**.

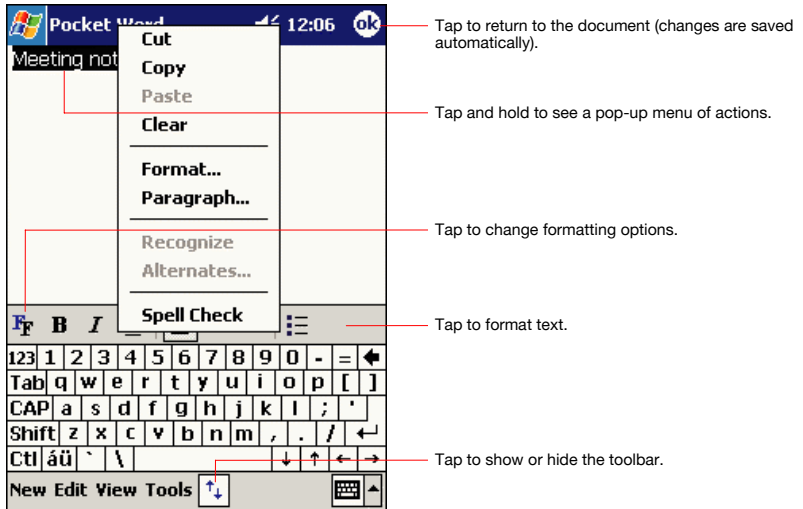

Writing Mode

In writing mode, use your stylus to write directly on the screen. Ruled lines are displayed as a guide, and the zoom magnification is greater than in typing mode to allow you to write more easily. For more information on writing and selecting writing, see Chapter 2.

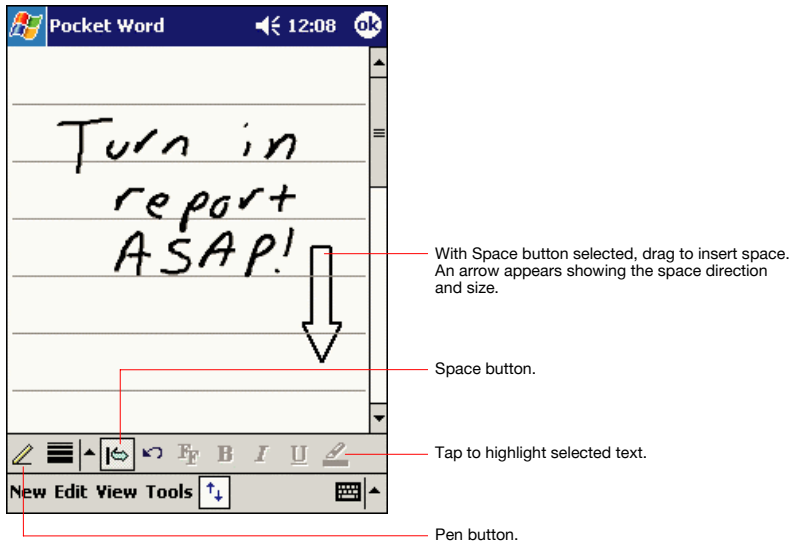

If you cross three ruled lines in a single stylus stroke, the writing becomes a drawing, and can be edited and manipulated as described in the following section. Written words are converted to graphics (metafiles) when a Pocket Word document is converted to a Word document on your desktop computer.

Drawing Mode

In drawing mode, use your stylus to draw on the screen. Gridlines appear as a guide. When you lift your stylus off the screen after the first stroke, you'll see a drawing box indicating the boundaries of the drawing. Every subsequent stroke within or touching the drawing box becomes part of the drawing. For more information on drawing and selecting drawings, see Chapter 2.

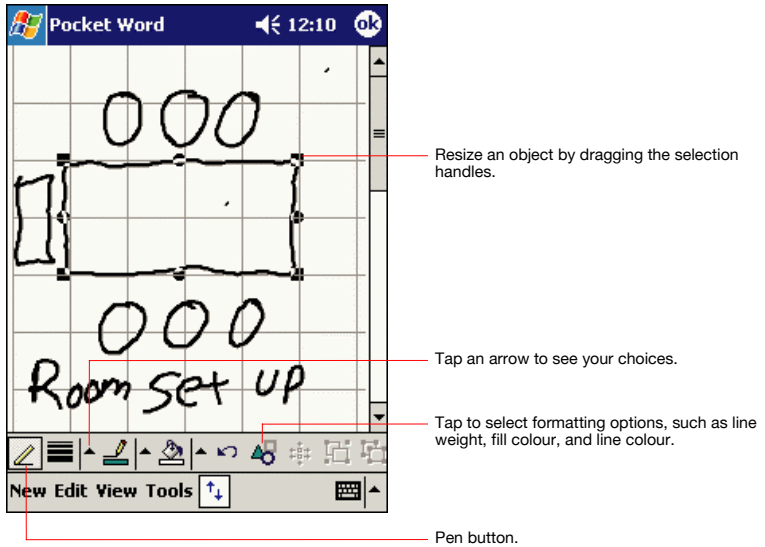

Recording Mode

In recording mode, embed a recording into your document. Recordings are saved as .wav files. For more information on recording, see Chapter 2. For more information on using Pocket Word, tap  and then **Help**.

Pocket Excel

Pocket Excel works with Microsoft Excel on your desktop computer to give you easy access to copies of your workbooks. You can create new workbooks on your device, or you can copy workbooks from your desktop computer to your device. Synchronize workbooks between your desktop computer and your device so that you have the most up-to-date content in both locations.

Use Pocket Excel to create workbooks, such as expense reports and mileage logs. To create a new file, tap **Programs**, **Pocket Excel**, and then **New**. A blank workbook appears. Or, if you've selected a template for new workbooks in the **Options** dialog box, that template appears with appropriate text and formatting already provided. You can open only one workbook at a time; when you open a second workbook, you'll be asked to save the first. You can save a workbook you create or edit in a variety of formats, including Pocket Excel (.pxl) and Excel (.xls).

Pocket Excel contains a list of the files stored on your device. Tap a file in the list to open it. To delete, make copies of, and send files, tap and hold a file in the list. Then select the appropriate action from the pop-up menu.

Pocket Excel provides fundamental spreadsheet tools, such as formulas, functions, sorting, and filtering. To display the toolbar, tap **View** and then **Toolbar**.

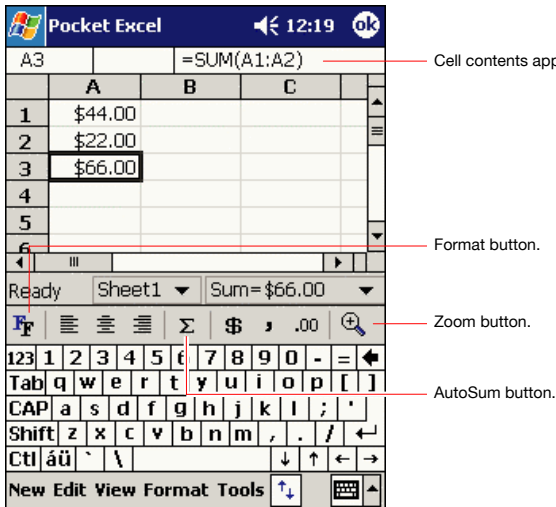

*If your workbook contains sensitive information, you can protect it with a password. To do so, open the workbook, tap **Edit**, and then **Password**. Every time you open the workbook, you will need to enter the password, so choose one that is easy for you to remember but hard for others to guess.*

Tips for Working in Pocket Excel

Note the following when working in large worksheets in Pocket Excel:

- View in full-screen mode to see as much of your worksheet as possible. Tap **View** and then **Full Screen**. To exit full-screen mode, tap **Restore**.
- Show and hide window elements. Tap **View** and then tap the elements you want to show or hide.
- Freeze panes on a worksheet. First select the cell where you want to **freeze panes**. Tap **View** and then Freeze Panes. You might want to freeze the top and leftmost panes in a worksheet to keep row and column labels visible as you scroll through a sheet.
- Split panes to view different areas of a large worksheet. Tap **View** and then **Split**. Then drag the split bar to where you want it. To remove the split, tap **View** and then **Remove Split**.
- Show and hide rows and columns. To hide a hidden row or column, select a cell in the row or column you want to hide. Then tap **Format**, then **Row** or **Column**, and then **Hide**. To show a hidden row or column, tap **Tools**, then **Go To**, and then type a reference that is in the hidden row or column. Then tap **Format**, then **Row** or **Column**, and then **Unhide**.

For more information on using Pocket Excel, tap  and then **Help**.

MSN Messenger

MSN® Messenger on your mobile device is an instant messaging program that lets you:

- See who is online.
- Send and receive instant messages.
- Have instant message conversations with groups of contacts.

To use MSN Messenger, you must have a Microsoft Passport™ account or a Microsoft Exchange e-mail account. You must have a Passport to use MSN Messenger Service. If you have a Hotmail® or MSN account, you already have a Passport. Once you have obtained either a Microsoft Passport or a Microsoft Exchange account, you are ready to set up your account.



*Sign up for a Microsoft Passport account at <http://www.passport.com>.
Get a free Microsoft Hotmail e-mail address at <http://www.hotmail.com>.*

To switch to MSN Messenger, tap , **Programs**, and then tap **MSN Messenger**.

Setting Up

Before you can connect, you must enter Passport or Exchange account information.

To set up an account and sign in:

- 1 In the **Tools** menu, tap Options .
- 2 In the **Accounts** tab, enter your Passport or Exchange account information.
- 3 To sign in, tap the sign-in screen and enter your e-mail address and password.



If you already use MSN Messenger on your desktop computer, your contacts will show up on your device without being added again.

Working with Contacts

The MSN Messenger window shows all of your messenger contacts at a glance, divided into Online and Not Online categories. From this view, while connected, you can chat, send ae-mail, block the contact from chatting with you, or delete contacts from your list using the pop-up menu.

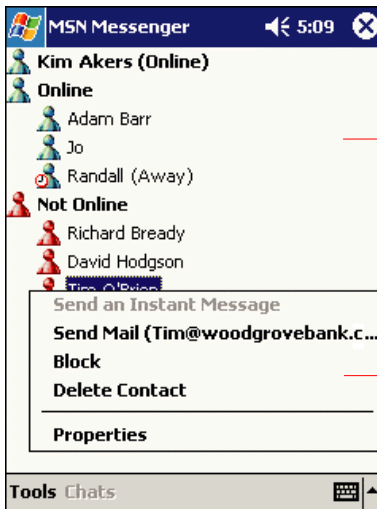

Tap a contact to start a chat.

Tap and hold to see a pop-up menu of actions.



*To see others online without being seen, in the **Tools** menu, tap **My Status** and select **Appear Offline**.*

*If you block a contact, you will appear offline but will remain on the blocked contact's list. To unblock a contact, tap and hold the contact, then tap **Unblock** on the pop-up menu.*

Chatting with Contacts

Tap a contact name to open a chat window. Enter your message in the text entry area at the bottom of the screen, or tap My Text to enter a preset message, and tap **Send**. To invite another contact to a multi-user chat, in the Tools menu, tap Invite and tap the contact you want to invite.

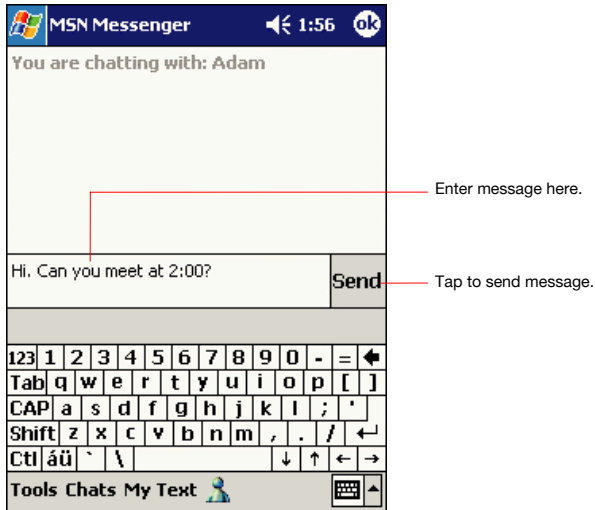

To switch back to the main window without closing a chat, tap the **Contacts** button. To revert back to your chat window, tap **Chats** and select the person whom you were chatting with.

To know if the contact you are chatting with is responding, look for the message under the text entry area.

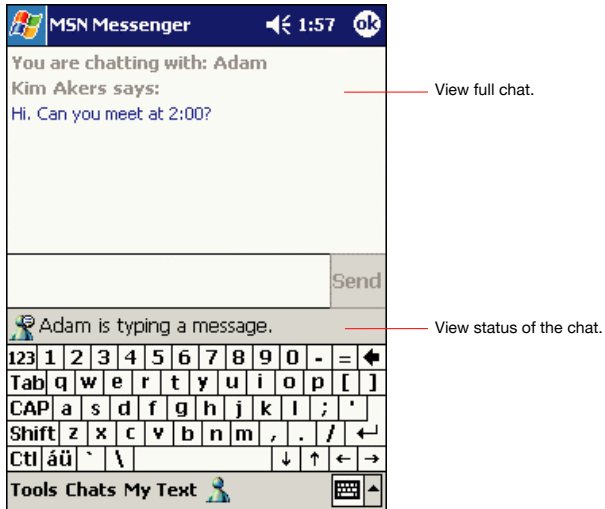

For more information on using MSN Messenger, tap  and then **Help**.

Windows Media Player

Use Microsoft Windows Media Player to play digital audio and video files that are stored on your device or on a network. To switch to Windows Media Player for Toshiba Pocket PC, tap , **Programs**, and then tap **Windows Media**.

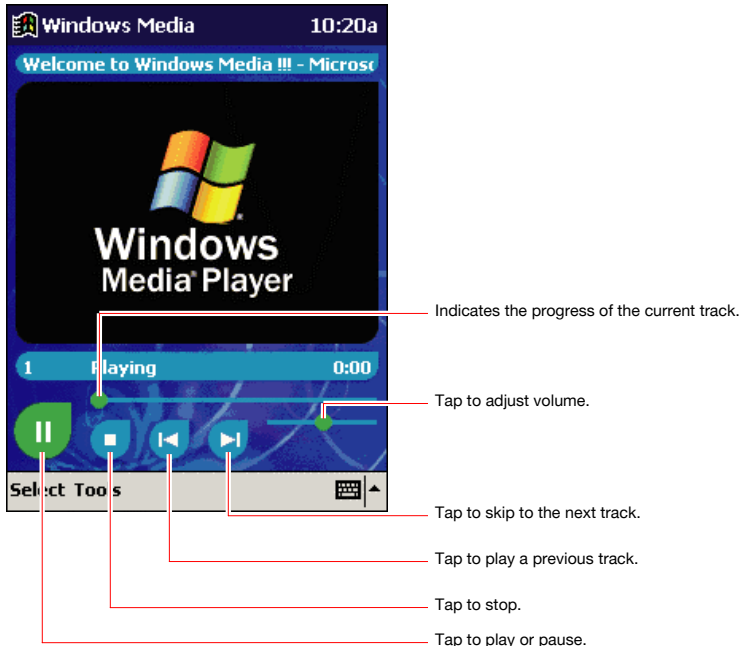

Use Microsoft Windows Media Player on your desktop computer to copy digital audio and video files to your Toshiba Pocket PC. You can play Windows Media and MP3 files on your Toshiba Pocket PC.

For more information about using Windows Media Player for Toshiba Pocket PC, tap , and then tap **Help**.

Microsoft Reader

Use Microsoft Reader to read eBooks on your device. Download books to your desktop computer from your favorite eBook Web site. Then, use ActiveSync to copy the book files to your activated device. The books appear in the Microsoft Reader Library, where you can tap them in the list to open them.

Each book consists of a cover page, an optional table of contents, and the pages of the book. You can:

- Page through the book by using the Up/Down control on your device or by tapping the page number on each page.
- Annotate the book with highlighting, bookmarks, notes, and drawings.
- Search for text and look up definitions for words.

The Guidebook contains all the information you'll need to use the software.

To open the Guidebook, tap **Help** on the Microsoft Reader command bar. Or, on a book page, tap and hold on the book title, and then tap **Help** on the pop-up menu.

To switch to Microsoft Reader, tap , **Programs**, and then **Microsoft Reader**.

Getting Books on Your Device

You can download book files from the Web. Just visit your favorite eBook retailer and follow the instructions to download the book files.

Sample books and a dictionary are also included in MSReader in the Extras folder on the Toshiba Pocket PC Companion CD.

Use ActiveSync to download the files from your desktop computer to your activated device as described in the Read Me file in the MSReader folder.

Using the Library

The Library is your MSReader home page; it displays a list of all books stored on your device or storage card.

To open the Library:

- On the MSReader command bar, tap **Library**.
- On a book page, tap the book title, and then tap **Library** on the popup menu.

To open a book, tap its title in the Library list.

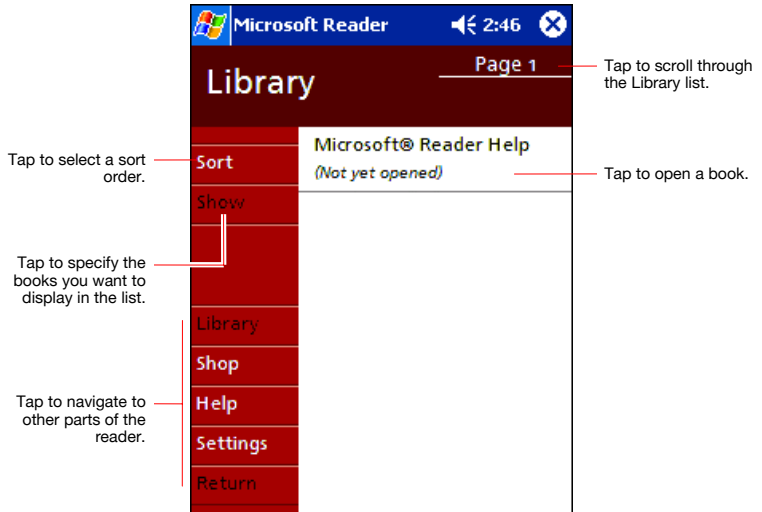

Reading a Book

Each book consists of a cover page, an optional table of contents, and the actual pages of the book. Navigation options are listed in the bottom portion of the cover page.

The first time you open a book, go to the first page or to the table of contents, if there is one. Subsequently, whenever you open the book, you'll be automatically taken to the last page read.

In addition to the text, each book page includes a page number and book title.

You can also page through a book by using the Up/Down control on your device.

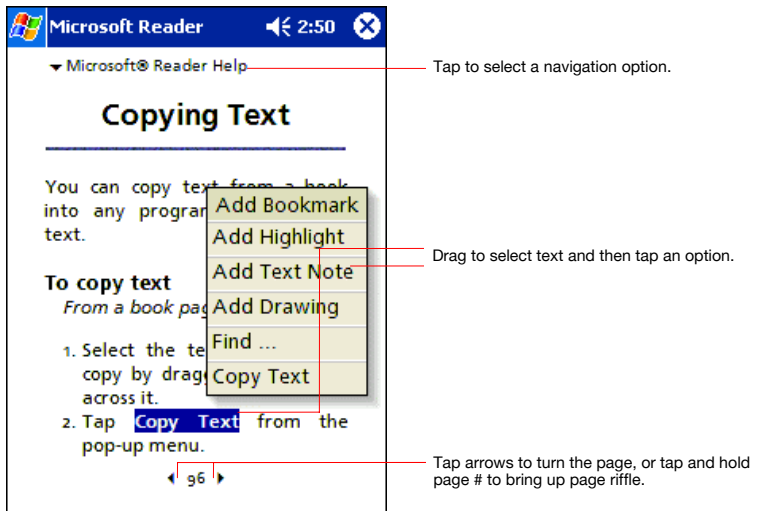

Using Reader Features

Reading a book electronically gives you several options not available with paper books. These options are available on any book page.

Select text by dragging across the text on the page. Then, tap an option on the pop-up menu, as described here:

- **Search for Text:** Find text in a book by tapping **Find** on the pop-up menu. Enter the word you want to search for, and tap the desired **Find** option. MSReader highlights the text on the page. To close **Find**, tap outside the box. To return to your original page, tap the title and then tap **Return** on the pop-up menu.
- **Copy Text:** You can copy text from books that support this feature into any program that accepts text. On a book page, select the text you want to copy. Then, tap **Copy Text** on the pop-up menu. The text can be pasted into the program of your choice.
- **Bookmarks:** When you add a bookmark to a book, a color-coded bookmark icon appears in the right margin. You can add multiple bookmarks to a book. Then, from anywhere in the book, tap the bookmark icon to go to the bookmarked page.
- **Highlights:** When you highlight text, it appears with a colored background.
- **Notes:** When you attach a note to text, you enter the text in a note pad that appears on top of the book page. A Note icon will display in the left margin. To show or hide the note, tap the icon.

- **Drawings:** When you add a drawing, a Drawing icon appears in the bottom-left corner of the page, and drawing tools appear across the bottom of the page. Draw by dragging your stylus.
- To see a list of a book's annotations, including bookmarks, highlights, text notes, and drawings, tap **Annotations Index** on the book's cover page. You can tap an entry in the list to go to the annotated page.

Removing a Book

When you finish reading a book, you can delete it to conserve space on your device. If a copy of the book is stored on your desktop computer, you can download it again at any time.

To remove a book from your device, tap and hold the title in the Library list, and then tap **Delete** on the pop-up menu.

Pocket Internet Explorer

Use Microsoft® Pocket Internet Explorer to view Web or WAP pages in either of these ways:

- During synchronization with your desktop computer, download your favorite links and mobile favorites that are stored in the Mobile Favorites subfolder in Internet Explorer on the desktop computer.
- Connect to an Internet service provider (ISP) or network and browse the Web. To do this, you'll need to create the connection first, as described in Chapter 7.

When connected to an ISP or network, you can also download files and programs from the Internet or intranet.

To switch to Pocket Internet Explorer, tap  and then **Internet Explorer**.

The Mobile Favorites Folder

Only items stored in the Mobile Favorites subfolder in the Favorites folder in Internet Explorer on your desktop computer will be synchronized with your device. This folder was created automatically when you installed ActiveSync.

Favorite Links

During synchronization, the list of favorite links in the Mobile Favorites folder on your desktop computer is synchronized with Pocket Internet Explorer on your device. Both computers are updated with changes made to either list each time you synchronize. Unless you mark the favorite link as a mobile favorite, only the link will be downloaded to your device, and you will need to connect to your ISP or network to view the content. For more information on synchronization, see ActiveSync Help on the desktop computer.

Mobile Favorites

If you are using Microsoft Internet Explorer 5.0 or later on your desktop computer, you can download mobile favorites to your device. Synchronizing mobile favorites downloads Web content to your device so that you can view pages while you are disconnected from your ISP and desktop computer.

Use the Internet Explorer plug-in installed with ActiveSync to create mobile favorites quickly.

To create a mobile favorite:

- 1 In Internet Explorer on your desktop computer, click **Tools** and then **Create Mobile Favorite**.
- 2 To change the link name, enter a new name in the **Name** box.
- 3 In **Update**, select a desired update schedule.
- 4 Click **OK**. Internet Explorer downloads the latest version of the page to your desktop computer.
- 5 If you want to download the pages that are linked to the mobile favorite you just created, in Internet Explorer on your PC, right-click the mobile favorite and then click **Properties**. In the **Download** tab, specify the number of links deep you want to download. To conserve device memory, go only one level deep.
- 6 Synchronize your device and desktop computer. Mobile favorites that are stored in the Mobile Favorites folder in Internet Explorer are downloaded to your device.



*If you did not specify an update schedule in step 3, you will need to manually download content to keep the information updated on your desktop computer and device. Before synchronizing with your device, in Internet Explorer on your desktop computer, click **Tools** and then **Synchronize**. You will see the last time content was downloaded to the desktop computer, and you can manually download content if needed.*

*You can add a button to the Internet Explorer toolbar for creating mobile favorites. In Internet Explorer on your desktop computer, click **View**, **Toolbars**, and then **Customize**.*

To save device memory

Mobile favorites take up storage memory on your device. To minimize the amount of memory used:

- In the settings for the Favorites information type in ActiveSync options, turn off pictures and sounds, or stop some mobile favorites from being downloaded to the device. For more information, see ActiveSync Help.
- Limit the number of downloaded linked pages. In Internet Explorer on the desktop computer, right-click the mobile favorite you want to change and then **Properties**. In the **Download** tab, specify 0 or 1 for the number of linked pages you want to download.

Using AvantGo Channels

AvantGo is a free interactive service that gives you access to personalized content and thousands of popular Web sites. You subscribe to AvantGo channels directly from your device. Then, you synchronize your device and desktop computer, or connect to the Internet to download the content. For more information, visit the AvantGo Web site.

To sign up for AvantGo:

- 1 In ActiveSync options on the desktop computer, turn on synchronization for the AvantGo information type.
- 2 In Pocket Internet Explorer on your device, tap the Favorites button to display your list of favorites.
- 3 Tap the AvantGo Channels link.
- 4 Tap the Activate button.
- 5 Follow the directions on the screen. You will need to synchronize your device with your desktop computer and then tap the My Channels button to complete the AvantGo setup.

When synchronization is complete, tap the AvantGo Channels link in your list of favorites to see a few of the most popular channels. To add or remove channels, tap the **Add** or **Remove** link.

Using Pocket Internet Explorer

You can use Pocket Internet Explorer to browse mobile favorites and channels that have been downloaded to your device without connecting to the Internet. You can also connect to the Internet through an ISP or a network connection and browse the Web.

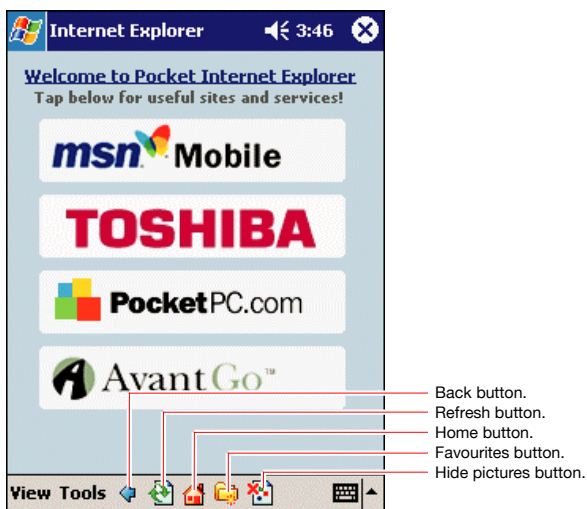

To view mobile favorites and channels:

- 1 Tap the Favorites button to display your list of favorites.

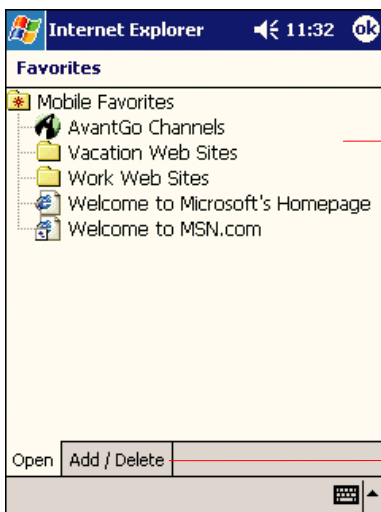

Tap the favourite you want to view.

Tap to add or delete a folder or favourite link.

- 2 Tap the page you want to view.

You'll see the page that was downloaded the last time you synchronized with your desktop computer. If the page is not on your device, the favorite will be dimmed. You will need to synchronize with your desktop computer again to download the page to your device, or connect to the Internet to view the page.

To browse the Internet:

- 1 Set up a connection to your ISP or corporate network using **Connections**, as described in Chapter 7.
- 2 To connect and start browsing, do one of the following:
 - Tap the Favorites button, and then tap the favorite you want to view.
 - Tap **View** and then **Address Bar**. In the address bar that appears at the top of the screen, enter the Web address you want to visit and then tap **Go**. Tap the arrow to choose from previously entered addresses.



*To add a favorite link while using the device, go to the page you want to add, tap and hold on the page, and tap **Add to Favorites**.*

Getting Connected

You can use your device to exchange information with other mobile devices as well as your desktop computer. You have the following connection options:

- Use the infrared (IR) port on your device to send and receive files between two devices. If this is the method you want to use, see the following section “Transfer Items Using Infrared.”
- Connect to your desktop computer to synchronize remotely. Once connected, you can synchronize information such as your Pocket Outlook information. If this is the method you want to use, see ActiveSync Help on your desktop computer or Connections Help on the device.

Transfer Items Using Infrared

Using infrared (IR), you can send and receive information, such as contacts and appointments, between two devices.

To send information:

- 1 Switch to the program where you created the item you want to send and locate the item in the list.
- 2 Align the IR ports so that they are unobstructed and within a close range.
- 3 Tap and hold the item, and tap **Beam Item** on the pop-up menu.



*You can also send items, but not folders, from File Explorer. Tap and hold the item you want to send, and then tap **Beam File** on the pop-up menu.*

To receive information:

- 1 Align the IR ports so that they are unobstructed and within a close range.
- 2 Have the owner of the other device send the information to you. Your device will automatically receive it.

Get Help on Connecting

More information on the procedures described here, as well as information on additional procedures, can be found in the following locations:

- Inbox: Sending and Receiving E-mail Messages in Chapter 4.
- Online Help on the Pocket PC. Tap  and then **Help**. Tap **View, All Installed Help**, and then **Inbox** or **Connections**.
- ActiveSync Help on the desktop computer. In ActiveSync, click **Microsoft ActiveSync Help** on the **Help** menu.
- For troubleshooting information, see the PocketPC Web site at: <http://www.microsoft.com/mobile/pocketpc>.

Optional Functions

Home

You can launch the built-in or installed applications easily by tapping the icon displayed on the Home screen. You can also set to display a desired bitmap image on your screen background.

Launching an Application From the Home

- 1 Tap , **Programs**, and then **Home** to display the Home screen. You can also launch the Home by pressing the Toshiba Pocket PC Home button.

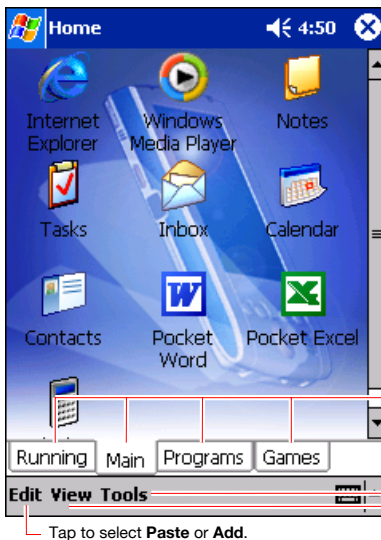

For initial setting, the respective application icons are registered on three tabs: **Main**, **Programs** and **Games**. In the **Running** tab, active applications are displayed.

- 2 Tap the desired tab, and then tap the application icon you want to launch. The selected application starts up.



Also, you can launch an application by moving the cursor button or scroller to select and pressing the center of the cursor button to confirm. You can add tabs up to a maximum of 10 kinds and icons up to 18 in a tab.

About Running

In the **Running** tab, the active application names are displayed. The icons do not appear.

Application Activate/Stop:



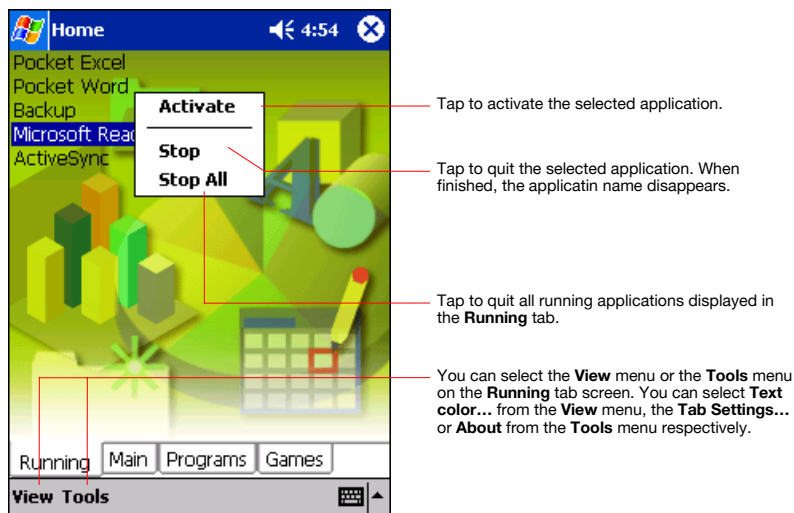











Tap the application name you want to activate. You can also activate the application from the pop-up menu displayed by tapping and holding the application name.



You can show a pop-up menu by tapping and holding any portion other than the application names displayed in the **Running** tab. In this case, only the **Stop All** is selectable.

Display Icon List

The following list shows the tabs and icons for the initial setup.

Tabs	Icons	Applications
Running	—	—
Main		Pocket Internet Explorer
		Windows Media Player
		Notes
		Tasks
		Inbox
		Calendar
		Contacts
		Pocket Word
		Pocket Excel
		Calculator
Programs		File Explorer
		Backup
		Infrared Receive
Games		Solitaire

Moving an Application Icon into Another Tab

The moved icon is placed next to the last icon on the tab screen. You cannot move an icon into a tab which already contains 18 icons.

To move using pop-up menu:

- 1 Tap and hold the icon you want to move to display the pop-up menu.
- 2 Tap **Cut** on the pop-up menu.
- 3 Tap the destination tab, and then tap **Paste** on **Edit** menu. The selected icon is pasted on the screen.



You can also select **Paste** from the pop-up menu displayed by tapping and holding any portion other than the icon.

Deleting an Icon

- 1 Tap and hold the icon you want to delete to display the pop-up menu.
- 2 Tap **Drop** on the pop-up menu. The icon is deleted and the next icon positioned after the deleted icon automatically shifts to fill the deleted icon position. And all icons after the deleted icon likewise shift to fill the previous icon position.

Adding an Icon

You can add the application and your file icons to the Home screen.

- 1 Tap **Edit** and then **Add** to display the Add Application screen. You can also select **Add** from the pop-up menu displayed by tapping and holding any portion other than the icon.
- 2 Tap ▼ of Application file to show the file list. If there is no desired file on the file list, you can find it by tapping **Browse**. To refer to all folders and files, tap **Browse** to show the Browse Dialog screen. When the file is selected, its name is displayed in the Application file box.

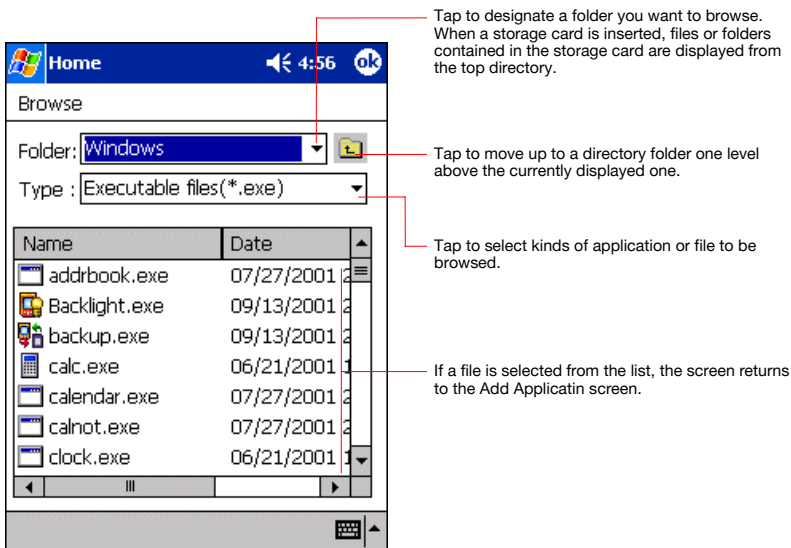

- 3 Enter an icon name in the Application name box, which is to be displayed on the Home screen. You can enter up to a maximum of 32 characters.
- 4 When finished, tap **OK** to close the Add Application screen, and the new icon is added to the Home screen.



If the Application file is not designated, or if the Application name is not entered, you cannot add a new icon.

You cannot launch the icon added from the storage card, if the same card is not inserted in the Toshiba Pocket PC.

Tab Setting

You can set to add, delete or rename the tab on the Tab Settings screen. You can also set to display a desired bitmap image on your screen background.

To add a tab:

- 1 Tap **Tools** and then **Tab Settings** to display the Tab Settings screen.
- 2 Tap **Tab Settings** and then **New** to display a box to enter the new tab name.
- 3 Enter a new tab name. When finished, tap **OK** to return to the Tab Settings screen. You can enter up to a maximum of 10 characters.
- 4 Tap **OK** on the Tab Settings screen to return to the Home screen.

To delete a tab:

- 1 Tap **Tools** and then **Tab Settings**.
- 2 Select the tab name to delete, and then tap **Delete**, the Delete tab dialog for confirming appears. Please note that all the icons contained in the same tab will also be deleted.
- 3 Tap **OK** on the Delete tab dialog to delete the tab. When finished, the screen returns to Tab Settings screen.
- 4 Tap **OK** on the Tab Settings screen to return to the Home screen.



*You cannot delete the **Running** tab.*

To change the name of a tab:

- 1 Tap **Tools** and then **Tab Settings** to display the Tab Settings screen.
- 2 Select the tab name you want to change, and then tap **Rename**.
- 3 Enter a new tab name. When finished, tap **OK** to return to the Tab Settings screen. You can enter up to a maximum of 10 characters.
- 4 Tap **OK** on the Tab Settings screen to return to the Home screen.



*You cannot rename the **Running** tab.*

To change a background:

- 1 Tap **Tools** and then **Tab Settings** to display the Tab Settings screen.
- 2 Select the tab of which background you want to change.
- 3 Tap **Browse** to display the Browse dialog screen.
- 4 Tap the desired bitmap file from the list to return to the Tab Settings screen.
- 5 Tap **OK** on the Tab Settings screen to return to the Home screen.



If the selected file is not a bitmap file, you cannot set it on your screen background. The displayable range of the bitmap image on the Home screen is 240(W) x 246(H).

Text Color Setting:

You can set the color of application name for each tab using Text Color.

- 1 Tap the tab whose color you want to set to display the selected tab screen.
- 2 Tap **View** and then **Text Color** to display the color list.
You can set the color of the application name as desired.
- 3 Tap the color you want to set, and the color of the application name changes.

Home Help

Tapping an icon displayed at “Home” launches that application. In addition to applications, it is also possible to register icons for associated files here. The Home screen is divided into tabs. There are 4 tab types as default, and up to 10 types of tab can be registered. As for the icons on the tab, up to 18 icons per one tab can be registered.

A bitmap image can be used as the background for the tab screen.

(1). “Running” tab

The names of currently running applications are displayed at the “Running” tab.

Applications can be switched or quit here.

“Text Color” can be selected from the “View” menu, and “Tab Settings” and “About” can be selected from the “Tools” menu.

- To activate applications, tap and hold the name of the application you want to activate to, then tap “Activate” from the pop-up menu.
- To stop an application, tap and hold the name of the application you want to stop, then choose “Stop” from the pop-up menu. If “Stop all” is selected from the pop-up menu, all currently running applications are stopped.
- “Stop all” can also be selected by tapping and holding on the “Running” tab screen without selecting an application name.

(2).Launching applications

When an icon on the tab screen is tapped, the application or associated file registered at the icon is launched.

- Applications can also be launched by selecting them with the cursor button then pressing on the center of the cursor button.

(3).Switching the icon display

Tap on the “View” menu to display the current display settings. Current display settings are indicated by check mark at the left. To switch the display, select “Large Icon” or “Small Icon”.

(4).Icon settings

1. Moving icons (using the pop-up menu)

- 1 Tap and hold the icon you want to move on the tab screen.
 - 2 When the pop-up menu appears, select “Cut” from the menu.
 - 3 Tap on the tab to which you want to move the icon, then tap “Paste” from the “Edit” menu to move the icon and display it on the tab screen.
- “Paste” can also be selected from the pop-up menu displayed when you tap and hold at a position on the screen other than on icon.
 - It is not possible to move icons to tabs already containing 18 icons. When an icon is moved, it is positioned at the very end of the tab’s icons.

2. Deleting icons

- 1 Tap and hold the icon you want to delete. A pop-up menu appears.
 - 2 Tap “Drop” from the pop-up menu to delete the selected icon from the tab screen.
- When an icon is deleted, subsequent icons are all moved up one place.

3. Adding icons

- 1 Tap the tab to which you want to add an icon to select that tab.
 - 2 Tap “Add” from the “Edit” menu to display the “Add Application” screen.
 - 3 Tap the “Application file” box.
 - 4 From the list, tap the application you want to add. To select a file not on the list, tap the “Browse” button, then select the file from the Browse Dialog.
 - 5 Input the name of the icon you want to add (up to 32 characters) in the “Application name” box.
 - 6 Tap the “OK” button. The new icon is added.
- Associated files can be specified for added icons.
 - If either one of “Application file” or “Application name” is not filled in, an icon can not be added.

4. Browse Dialog

- 1 Tap the “Folder” box to select the folder to be browsed.
 - 2 Tap the “Type” box to select the type of file to be browsed.
 - 3 The list of the files of the specified type and in the specified folder appears on the screen. Select the desired application or file or the bitmap image to be used as the background and tap it. The original screen reappears.
- If a storage card is inserted into the main unit when adding icons, icons of applications and files on the storage card are also displayed on the browse screen. The folders and files on the storage card can be displayed in the “Folder” box, beginning at the topmost level.
 - If an icon on a storage card is added, that storage card must be inserted when the icon is tapped or the file will not be launched.

(5).Tab settings

1. Switching tabs

Tap on another tab to switch the tab screen.

Initially four tabs are registered: “Running”, “Main”, “Programs” and “Games”.

2. Changing tab names

- 1 Select “Tab Settings” from the “Tools” menu. The “Tab Settings” screen appears.
- 2 Tap the “Select tab” box to select the tab to be changed.
- 3 Tap the “Rename” button. The screen for inputting the new tab name appears.
- 4 Input the new tab name (up to 10 characters) into the “Rename to” box.

- 5 Tap the “OK” button. The tab name is changed and the “Tab Settings” screen reappears.
- 6 Tap “OK” at the upper right to return to the Home screen.

3. Deleting tabs

- 1 Select “Tab Settings” from the “Tools” menu. The “Tab Settings” screen appears.
 - 2 Tap the “Select tab” box to select the tab to be deleted.
 - 3 Tap the “Delete” button. A dialog asking you to confirm you want to delete the tab appears.
 - 4 Tap the “Yes” button. The tab is deleted and the “Tab Settings” screen reappears.
 - 5 Tap “OK” at the upper right to return to the Home screen.
- Note that when a tab is deleted, all the icons on that tab are also deleted.
 - “Delete” cannot be selected if there are only two tabs on the Home screen.

4. Adding tabs

- 1 Select “Tab Settings” from the “Tools” menu. The “Tab Settings” screen appears.
- 2 Tap the “New” button. An input screen appears.
- 3 Input the name you want to give the tab (up to 10 characters) into the “New tab” box.
- 4 Tap the “OK” button. The new tab is added and the “Tab Settings” screen reappears.
- 5 Tap “OK” at the upper right to return to the Home screen.

5. Setting the background bitmap

- 1 Select “Tab Settings” from the “Tools” menu. The “Tab Settings” screen appears.
- 2 Select the tab whose background you want to set at the “Select tab” box.
- 3 Tap the “Browse” button to display the Browse Dialog.
- 4 Select and tap the bitmap image to be used as the background. The “Tab Settings” screen reappears.
- 5 Tap “OK” at the upper right to return to the Home screen.

6. Setting the text color

Different colors can be set for the application names at the different tabs.

- 1 Display the tab whose color you want to set, then select “Text Color” from the “View” menu.
- 2 Tap the color you want to set from the list of display colors. That color is set for the application names.

How to Make a Backup

You can make a backup of the Toshiba Pocket PC data to a SD Memory Card. If you have backed up your data on a SD Memory card, you can restore that data in your Toshiba Pocket PC. You can also delete backup file data from the SD Memory card. Periodical data backup is recommended.

Data of the following three types can be backed up:

File: Includes a file created by Pocket Word, Pocket Excel, Notes, etc. or an additionally installed program and so on.

Registry: Setting information on Windows CE or Built-in Program.

Database: Database information of Microsoft Pocket Outlook.



*If you update ROM programs using special installation programs with a *.xip extension, do not use the backup data which you made before updating ROM programs.*

When using the Databackup, beware of the remaining battery charge.

Making a Backup

- 1 Insert an **SD Memory Card**.
- 2 Tap **Start, Programs**, and then **DataBackup** to display the DataBackup screen.
- 3 Set a **Custom Name**, if you want.
- 4 Tap **Backup** to display the Prompt message screen.
- 5 Tap **OK**. The Proceeding message is displayed during the backup process. When the backup is completed, a backup finished message appears.
- 6 Tap **OK** to return to the previous screen.

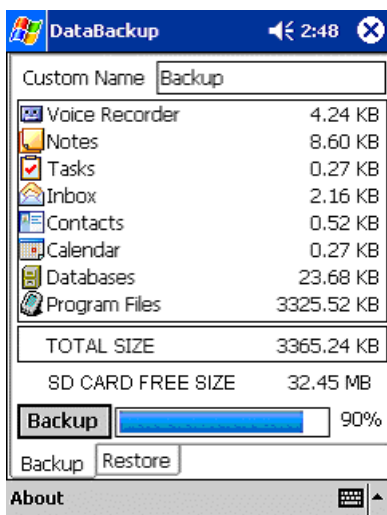

If the SD Memory card does not have enough free capacity, the backup process stops. Check the storage capacity before starting the backup.

If the SD Memory card is write protected, you cannot save the backup data. Cancel the write protection before starting the backup.

Carrying Out Restore Operation

To restore is to overwrite the backed up data from the SD Memory card onto the main memory of your Toshiba Pocket PC. If the same file name exists in the main memory of your Toshiba Pocket PC, the file data is replaced with the backup data from the SD Memory card. If files exist in the main memory but not in the backup file, they will not be overwritten.

- 1 Insert the SD Memory card, which contains backup data into your Toshiba Pocket PC.
- 2 Tap **Start, Programs**, and then **DataBackup** to display the DataBackup screen.
- 3 Select **Restore** from tab.
- 4 Select backup file from restored files list.
- 5 Tap **Delete** if want to delete backup file.
- 6 Tap **Refresh** if want to refresh Storage Card.
- 7 Tap **Restore** to display the Prompt message screen.
- 8 Tap **OK**. The Proceeding message is displayed during the restore process.
When the restore is completed, a restore finished message appears.
- 9 Tap **OK**. Your Toshiba Pocket PC is reset and restarts automatically.

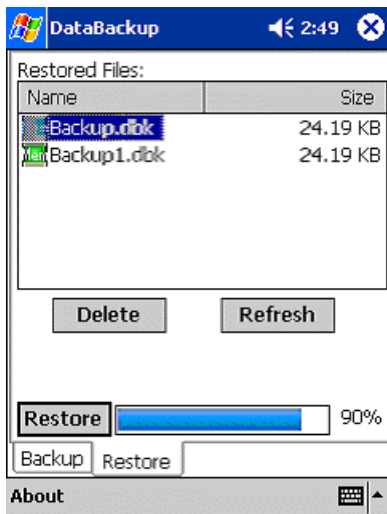

Data Backup Help

The backup function allows you to back up the data from the main unit on storage cards. The backed up data can be restored and deleted.

Before performing the backup or restore operation, check that there is enough space in the main unit's memory and on the storage card.

(1).Loading the storage card

- Make sure the main unit's power is off when loading and unloading the storage card.
- Insert the storage card in the designated card slot, making sure to do so in the proper direction.
- Save current data in the main unit's memory before backing it up on the storage card.

(2).Making backups

- 1 Select "DataBackup" from "Programs" in the "Start" menu.
- 2 Once the backup screen appears, tap the "Backup" tab.
- 3 Set a **Custom Name** if you want.
- 4 Tap the "Backup" button.
- 5 A message appears once backing up is completed.
- 6 Tap "OK" at the upper right to return to the previous screen.

(3).Restoring the data

Use this operation to restore the backup data stored on the storage card into the main unit. The data in the backup file is copied over the data in the main unit's memory.

- If a file with the same name already exists in the main unit's memory, its data is replaced with the data in the backup file.
 - Files in the main unit's memory not included in the backup file remain in the main unit's memory.
- 1 Select "DataBackup" from "Programs" in the "Start" menu.
 - 2 Once the backup screen appears, tap the "Restore" tab.
 - 3 Select a backup file from the **Restored Files** list.
 - 4 Tap the "Restore" button.
 - 5 A message appears once the restore operation is completed.
 - 6 Tap "OK" button. The main unit is reset and restarted.



(4).Deleting a backup file

- 1 Select “DataBackup” from “Programs” in the “Start” menu.
- 2 Once the backup screen appears, tap the “Restore” tab.
- 3 Select a backup file from the **Restored Files** list.
- 4 Tap the “Delete” button. A message screen asking you to confirm that you want to delete the backup file appears.
- 5 Tap the “OK” button.
The backup data is deleted from the storage card and the previous screen reappears.

Additional Information

Troubleshooting

Check the following guide for the possible cause of a problem and how to correct it.

Symptom	Cause	Correction
The power button is pressed but the power does not turn on.	The built-in battery power is exhausted.	Charge the battery.
The power was suddenly cut off.	The built-in battery power is exhausted.	Charge the battery.
	Automatic suspend is active.	Select  , Settings, System, Power to set to alter the power shut down time.
Even if the built-in battery is completely charged, it discharges after a short period of time.	The built in battery is extinct.	Replace the main battery with a new one.
The screen was tapped, but no correct action was not executed.	Touch screen adjustment is incorrect.	Select  , Settings, System, Align Screen to adjust the touch screen. If the screen alignment loses calibration it may not be possible to adjust alignment using the above method. In that case, the Align Screen command can be executed by simultaneously pressing the power button and scroll button.

Symptom	Cause	Correction
The screen was tapped, but there is no response. The operation button does not work either.	Unresponsive operating system	Reset the system. If no action is observed after resetting the system, initialize the system. (NOTE: YOUR DATA WILL BE DELETED.)
The screen is dark.	The front light is off.	Press and hold the power button until the front light is turned on or touch the screen with the stylus.
The screen is hard to see.	Brightness setting is incorrect.	Select  Settings, System, Front Light to adjust the screen brightness for better sight.
Can not connect to your computer.	—	See Help of ActiveSync.
ActiveSync does not function when your Pocket PC is connected to your computer with a USB cradle or USB cable.	“USB SETUP TOOL” was not executed. It should be performed after execution of ActiveSync.	Install “USB SETUP TOOL” contained in the Companion CD.
	The USB driver of your computer may not be compatible.	Reselect the USB driver.

Resetting

Reset is equal to "Restart" of a computer. Carry out when a button or tapping the screen does not respond. When your Toshiba Pocket PC is reset, all data that was not stored during operation will be deleted. Stored data will be saved.



If the function cannot be restored even if the reset button is pressed, initialize your Toshiba Pocket PC.

- When the power is on, press the reset button with the stylus, then release.

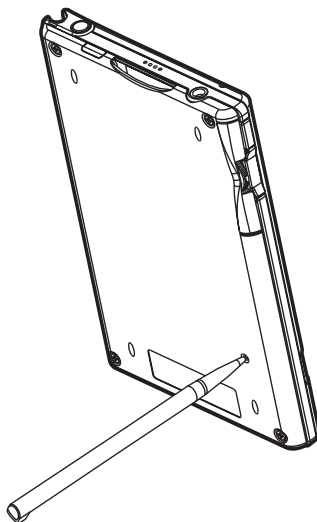

Initializing

When you initialize your Toshiba Pocket PC, it returns to the status when it was purchased.



When you initialize your Pocket PC, all data stored in the memory is deleted. Your Pocket PC's initially installed programs are not deleted. Before initialization, remove all storage cards.

- 1 Turn off the power.
- 2 Press the power button while pressing and holding the reset switch with the stylus, and then release the power button.
- 3 When a screen appears, release the reset switch. When initialization is completed, the Welcome screen appears. Set up the system according to the screen as in the case of startup procedure.

Specifications

External dimensions	78.75mm(W) x 15.25mm(D) x 124.5mm(H)
Weight	142g (5oz)
Operating conditions	Temperature: 0°C to 40°C, Humidity: 30 to 80% RH, when only the Pocket PC is operating Temperature capable of charging: 5°C to 35°C
Built-in battery	
Type	Advanced Lithium Ion battery
Continuous operating time	Approx. 10 hours. For continuous indication of the Today screen, front light: OFF, ambient temperature: 25°C
Memory keeping time	Approx. 72 hours. If left at ambient temperature of 25°C after the power has become unable to turn on Note: Continuing operating time and memory keeping time vary according to the charging condition, ambient temperature, operating condition, etc.
Processor	Strong ARM SA-1110
Action clock	206MHz
Memory	32MB SDRAM
Display	Reflection color TFT, 240x320 pixels, up to 64K colors

Interfaces**SD card slot**

SD memory card or SDI/O card

Note: The security function of the SD memory card is not usable. Data encrypted by the SD memory card security function-compatible equipment is not usable.**Infrared port**

Based on IrDA Ver.1.3

Maximum data transmission speed: 115 kbps

Stereo headphone jack

ø3.5mm, stereo mini plug compatible

Cradle connection port**DC-IN Socket**

AC adaptor

Input power supply: 100–240VAC, 50/60Hz, 33VA

Rated output: DC 5V, 2A

Although the display is manufactured using an extremely high order of technology, there may be a case that some dots do not light or always light. It is not a malfunction.