

***COMPAQ***

**IPAQ H3000 POCKET PC  
REFERENCE GUIDE**

# NOTICE

The information in this document is subject to change without notice.

COMPAQ COMPUTER CORPORATION SHALL NOT BE LIABLE FOR TECHNICAL OR EDITORIAL ERRORS OR OMISSIONS CONTAINED HEREIN; NOR FOR INCIDENTAL OR CONSEQUENTIAL DAMAGES RESULTING FROM THE FURNISHING, PERFORMANCE, OR USE OF THIS MATERIAL.

This document contains information protected by copyright. No part of this document may be photocopied or reproduced in any form without prior written consent from Compaq Computer Corporation.

© 2000 Compaq Computer Corporation.

Compaq and the Compaq log are registered in the U.S. Patent and Trademark Office. iPAQ is a trademark of Compaq Information Technologies Group, L.P. Microsoft, ActiveSync, Outlook, Pocket Outlook, Expedia, AutoRoute Express, MapPoint, Windows, Windows NT, and the Windows logo are either registered trademarks or trademarks of Microsoft Corporation in the United States and/or other countries. Microsoft products are licensed to OEMs by Microsoft Licensing, Inc., a wholly owned subsidiary of Microsoft Corporation.

Product names mentioned herein are may be trademarks and/or registered trademarks of their respective companies.

## ***iPAQ H3000 Pocket PC Reference Guide***

iPAQ H3000 Pocket PC

First Edition. May 2000.

177711-001

---

# TABLE OF CONTENTS

Chapter 1: Getting Started	1
Welcome	1
Where to Find Information	2
Symbols and Conventions	3
Customer Registration	3
How to Transfer Palm-size PC Data	4
Chapter 2: Basic Skills	1
Front Panel Components	1
Bottom Edge Components	3
USB Cradle and AC Adapter	4
Compaq iPAQ Expansion Pack System	6
The Stylus	9
Today Screen	10
Programs	11
Navigation Bar and Command Bar	13
Pop-up Menus	14
Notifications	14
Enter Information on Your iPAQ	15
Find Information	21
Customize Your iPAQ H3000	22
QStart	28
QUtilities and QMenu	29
Backup and Restore Data	32

Chapter 3: Microsoft ActiveSync	1
Chapter 4: Microsoft Pocket Outlook	1
Calendar: Scheduling Appointments and Meetings	2
Contacts: Tracking Friends and Colleagues	4
Tasks: Keeping a To Do List	7
Notes: Capturing Thoughts and Ideas	10
Inbox: Sending and Receiving E-mail Messages	12
Chapter 5: Companion Programs	1
Pocket Word	1
Pocket Excel	5
Microsoft Money	7
Windows Media Player for Pocket PC	11
Microsoft Reader	14
Pocket Streets	17
Chapter 6: Pocket Internet Explorer	1
The Mobile Favorites Folder	1
Favorite Links	1
Mobile Favorites	2
Channels	3
Use Pocket Internet Explorer	4

Chapter 7: Getting Connected	1
Transfer Items Using Infrared	2
Connect to an ISP	3
Connect to Your Network	4
End a Connection	7
Connect Directly to an E-mail Server	7
Get Help on Connecting	8
Appendix A: Tips and Troubleshooting	1
Reset the iPAQ H3000 and Clear Memory	1
Battery Loses Power	3
If You Forget Your Password	4
If You Run Out of iPAQ H3000 Memory	4
Screen Freezes or Responds Slowly	6
Screen is Blank	6
Screen is Dark	6
Screen is Hard to Read	7
Inaccurate Response to Stylus Taps	7
Slow or No Response	7
Infrared (IR) Connection Problems	7
Modem Connection Problems	8
Network Connection Problems	10
USB Cable Connection Problems	10
Routine Maintenance	11
Battery Guidelines	11
Travel Guidelines	12

Appendix B: Character Recognizer	1
Appendix C: Regulatory Notices	1
Regulatory Agency Identification Numbers	1
Federal Communications Commission Notice	2
Canadian Notice	3
Avis Canadien	3
European Union Notice	3
Battery Warning	3
Airline Travel Notice	3
Power Cords	4
Appendix D: Hardware Specifications	1
System Specifications	1
Physical Specifications	2
Operating Environment	2

# *chapter 1*

## GETTING STARTED

### Welcome

Congratulations on purchasing a Compaq iPAQ H3000 Windows Powered Pocket PC. Due to the size and capabilities of your iPAQ H3000 Pocket PC, you can keep your most important business and personal information up-to-date and close at hand. Microsoft® ActiveSync® increases the power of your iPAQ H3000 Pocket PC by allowing you to synchronize the information on your desktop or laptop computer with your Pocket PC. Picture yourself in the following situations:

- While walking with a colleague, your cell phone rings and your manager asks if the two of you are free this afternoon for an emergency meeting. While your colleague fumbles through his paper organizer, you press a button on your iPAQ H3000 and instantly see a list of the day's appointments and meetings. You are quickly able to tell your manager your available times. For more information on scheduling appointments and meetings, see Chapter 4.
- You're meeting your friends tonight for dinner and a movie. You download the latest movie information from the Internet onto your computer then synchronize it with your iPAQ H3000. At dinner, you pull out your iPAQ H3000 and review your movie options with your friends. For more information on downloading Web pages to your iPAQ H3000, see Chapter 6.
- A Calendar reminder alerts you that it's time to catch the bus to work. You grab your iPAQ H3000 and catch the bus just in time. Because ActiveSync keeps the information on your iPAQ H3000 up-to-date, you leisurely review your task list, make notes about the new books and CDs you want to buy, and read and respond to e-mail messages. When you get back to the office, ActiveSync transfers any task changes you made, your notes, and your e-mail message responses to your computer. For more information on ActiveSync, see Chapter 3.

# Where to Find Information

This reference guide describes your iPAQ H3000 Pocket PC hardware, provides an overview of the programs on your iPAQ H3000, and explains how to connect your iPAQ H3000 to a computer, a network, or the Internet. For instructions on setting up your iPAQ H3000, see the Quick Start Card. For instructions on installing ActiveSync, see the booklet accompanying the ActiveSync CD. The following table is a guide to additional information to help you use your iPAQ H3000:

For information on:	See this source:
<b>Programs on your iPAQ H3000</b>	This reference guide and iPAQ H3000 Help. To view Help, tap  then <b>Help</b> .
<b>Additional programs that can be installed on your iPAQ H3000</b>	The Extras folder, located on the ActiveSync CD.
<b>Connecting to and synchronizing with a computer</b>	The ActiveSync booklet or online ActiveSync Help on your computer. To view online Help, open Microsoft ActiveSync on your computer, then select <b>Help, Microsoft ActiveSync Help</b> .
<b>Last-minute updates and detailed technical information</b>	The Read Me files, located in the Microsoft ActiveSync folder on the computer and on the ActiveSync CD.
<b>Up-to-date information on Windows®-powered devices including tips and tricks</b>	Microsoft Windows Powered Home Page <a href="http://www.microsoft.com/windowsce/">www.microsoft.com/windowsce/</a> -or- <a href="http://www.microsoft.com/windowsce/products/tips">www.microsoft.com/windowsce/products/tips</a>
<b>The latest information and offers for your iPAQ</b>	Compaq Handheld Home Page <a href="http://www.compaq.com/products/handhelds">www.compaq.com/products/handhelds</a>
<b>Information on iPAQ accessories and ordering</b>	<i>Accessories Information</i>
<b>Tips and troubleshooting information</b>	Online ActiveSync Help on your computer. To view the online Help, open Microsoft ActiveSync on your computer, then select <b>Help, Microsoft ActiveSync Help</b> . -or- Appendix A, “Tips and Troubleshooting,” in this reference guide. -or- Compaq iPAQ Support Home Page <a href="http://www.compaq.com/support/handhelds">www.compaq.com/support/handhelds</a>
<b>Technical support and your warranty</b>	The <i>How Do I Get Service and Support for My Compaq iPAQ Pocket PC?</i> card.



# Symbols and Conventions

Some or all of the following format conventions may be used in this guide to distinguish elements of text:

- Names of menus, commands and icons are shown in bold type as they appear on the display, for example, **Settings**, **Power**.



Text set off in this manner indicates that failure to follow directions could result in bodily harm or loss of life.



Text set off in this manner indicates that failure to follow directions could result in damage to equipment or loss of information.

**NOTE:** Text set off in this manner presents commentary, sidelights, or interesting points of information.

## Customer Registration

You can receive the latest information on your iPAQ H3000 Pocket PC, as well as special offers on iPAQ H3000 accessories and software, by registering with Compaq by completing and mailing the *Register Now*\* card included in the shipping box or the online registration.

\* Not available in all regions.

# How to Transfer Palm-size PC Data

If you are currently using a Windows CE-based Palm-size PC and want to transfer your data to your iPAQ H3000 Pocket PC, follow this upgrade procedure:

1. Install Microsoft ActiveSync 3.1 on your computer. For information on installing ActiveSync, see the booklet accompanying the ActiveSync CD.
2. Synchronize your Palm-size PC with your computer so that the information on your computer is current.

**NOTE:** If you have files on your Palm-size PC that you want to transfer, such as Note Taker notes and recordings, turn file conversion off in ActiveSync options so that the files stay in device format, and use the ActiveSync Explorer to copy the files to your computer. For specific instructions, see ActiveSync Help on the computer.

3. Synchronize your iPAQ H3000 with your computer. This will update your device using the current data on your computer (step 2).
4. Reinstall programs. Check whether new versions are available.

**NOTE:** Some older Palm-size PC programs may not work on your iPAQ H3000 Pocket PC.

**NOTE:** Copy the files you transferred to your computer to your iPAQ H3000 using the ActiveSync Explorer. Turn file conversion on again in ActiveSync.

5. Enter your settings and connection information on the iPAQ H3000.

If you have offline folders in Inbox on your Palm-size PC that contain e-mail messages you want to transfer to your iPAQ H3000, follow this procedure:

1. Connect your Palm-size PC to your computer then click **Windows CE Inbox Transfer** on the Microsoft Outlook **Tools** menu.
2. Select **Copy or move selected messages to your computer**, then click **Browse**.
3. Select the offline folder that contains the messages you want to transfer to your computer, then click **OK**.
4. Click the **Transfer** button and select the folder you want to transfer the messages to or click **New Folder** to create a new folder. Click **OK** to transfer the messages. Now you must transfer the messages from your computer to your iPAQ H3000.
5. Tap **Tools** then **New Folder** and create a folder for the messages you are going to transfer in Inbox on your iPAQ H3000.
6. Select the messages you want to transfer in Outlook on your computer.
7. Connect your iPAQ H3000 to your computer, then click **Windows CE Inbox Transfer** on the Outlook **Tools** menu.
8. Select **Copy selected messages to your mobile device**, then click **Browse**.
9. Select the offline folder on your iPAQ H3000 that you want to transfer the messages to, then click **OK**.
10. Click the **Transfer** button. The selected messages are moved to your iPAQ H3000.

# chapter 2

## BASIC SKILLS

Learning to use your iPAQ H3000 Pocket PC is easy. This chapter describes the basic concepts of using and customizing your iPAQ H3000 Pocket PC.

### Front Panel Components

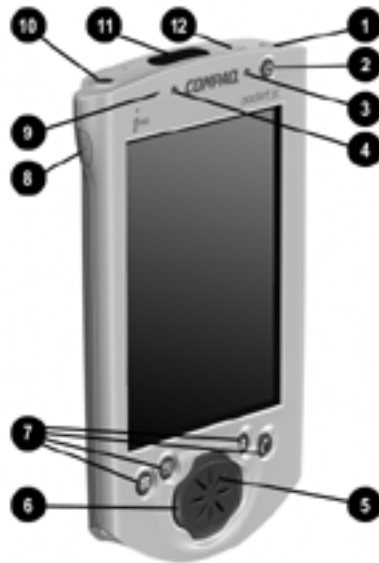

<u>Item</u>	<u>Component</u>	<u>Function</u>
1	Stylus	Allows you to tap or write on the screen. Push the stylus release button (12) to release it from the compartment.
2	Power Button	Powers the iPAQ H3000. Press and release the button to turn on or off your iPAQ H3000. Press and hold the button for one second to toggle on or off the backlight.

<u>Item</u>	<u>Component</u>	<u>Function</u>
<b>3</b>	Alarm/Charge Light	Serves as both a battery charge indicator and a visual alarm indicator. <ul style="list-style-type: none"> <li>• Flashing green: Notification alarm signal.</li> <li>• Flashing amber: Battery is charging.</li> <li>• Solid amber: Battery is fully charged</li> </ul>
<b>4</b>	Light Sensor	Detects the ambient light level so that the back-light level adjusts to suit the environment.
<b>5</b>	Speaker	Sounds alarms and plays back sound recordings.
<b>6</b>	iPAQ Navigator/ Action Button	Allows you to scroll through a list (similar to pressing the arrow keys on a keyboard). In the list view of a program, you can use your iPAQ Navigator to scroll to the item you want to view. Can also be used as game buttons within a game application. The center of the button can be used as an Action button to open a selected item.
<b>7</b>	Application Buttons	Allow quick access to four applications. By default, the applications are Calendar, Contacts, QMenu, and QStart. You can change the functions of the application buttons to open different applications. For more information, see “Adjusting Settings” later in this chapter.
<b>8</b>	Record Button	Activates the record function in Notes. For more information, see “Notes” in Chapter 4. You can change the function of the Record button so that it opens a different application. For more information, see “Adjusting Settings” later in this chapter.
<b>9</b>	Microphone	Allows you to record voice messages.
<b>10</b>	Headphone Jack	Lets you connect standard headphones.  To reduce the risk of personal injury, turn down the volume control before putting on headphones.
<b>11</b>	Infrared Port	Enables you to exchange data with other Windows-powered devices. The infrared port can transmit at speeds up to 115.2Kb per second. For more information, see Chapter 7.
<b>12</b>	Stylus Release Button	Lets you eject the stylus from its compartment.

## Bottom Edge Components

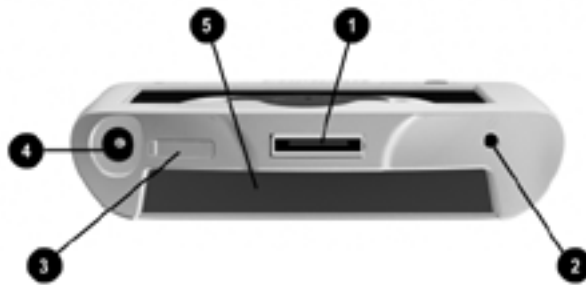

<u>Item</u>	<u>Component</u>	<u>Function</u>
1	Communications Port	Connects your iPAQ H3000 to the cradle (or to an optional USB or serial cable).
2	Reset Button	Lets you reset your iPAQ H3000. For more information, see “Reset the iPAQ H3000 and Clear Memory” in Appendix A.
3	On/Off Switch	Allows you to clear all data, and reset your system if you have forgotten your password. Clearing memory deletes all data and restores your iPAQ H3000 to its default settings. For more information, see “Reset the iPAQ H3000 and Clear Memory” in Appendix A.
4	DC Jack	Allows you to connect to external power with the supplied AC adapter.
5	iPAQ Expansion Pack Connector	Connects to the connector of an (optional) iPAQ Expansion Pack.

## USB Cradle and AC Adapter

Your iPAQ H3000 comes with a USB cradle and AC adapter. This allows you to recharge your iPAQ H3000, as well as *synchronize* the information between your iPAQ H3000 and a computer using ActiveSync. For more information on synchronization, see ActiveSync Help on your computer.

**NOTE:** The USB Cradle must be plugged into an available USB port on the back of your computer.

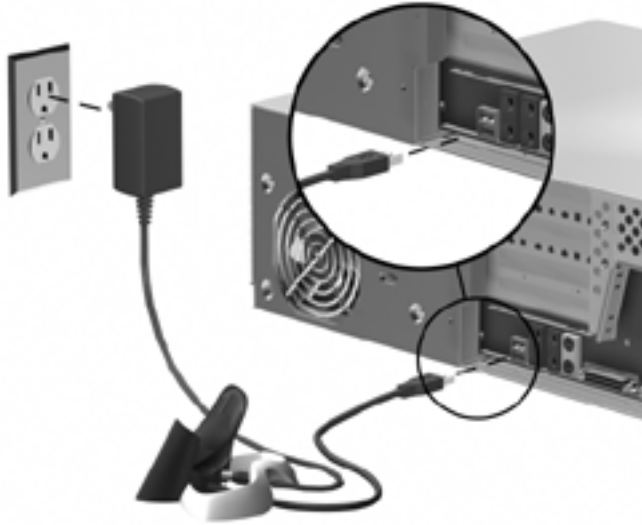

## Recharging the Battery

Your iPAQ H3000 contains a rechargeable Lithium Polymer battery that is recharged each time you place your iPAQ H3000 in the cradle and connect the cradle to an external power source with the AC adapter. You never need to replace the battery. Just place your iPAQ H3000 in the cradle for three to four hours for an initial charge before you use it the first time. Next, place it in the cradle for a short time each day to recharge the battery to its full capacity.



**NOTE:** You can also use the AC adapter to connect your iPAQ H3000 directly to the external power source.

If the battery gets very low, your iPAQ H3000 displays a warning message. If this occurs, save any unsaved data you are working on, perform a synchronization with your computer, then turn off your iPAQ H3000. Don't try to restart your iPAQ H3000 until you have connected to external power. The battery acts like a rechargeable backup battery by protecting your data if your iPAQ H3000 shuts down. If your iPAQ H3000 does shut down, you still have about 24 hours to recharge the battery before you lose the data on your Pocket PC.

# Compaq iPAQ Expansion Pack System

Your iPAQ features the iPAQ Expansion Pack System, which allows you to personalize the appearance of your iPAQ H3000 or add extra functionality. iPAQ Style Packs offer a range of styles to customize your iPAQ, while Expansion Packs, such as the CF Card, or PC Card Expansion Pack, let you add extra features.

Compaq iPAQ Expansion and Style Packs are designed to be easily slid on and off your Pocket PC without having to power off your Pocket PC first.

**NOTE:** For information on ordering Compaq iPAQ Expansion Packs, see the *Accessories Information* flier included in the shipping box, or visit the Compaq iPAQ H3000 home page at [www.compaq.com/products/handhelds/](http://www.compaq.com/products/handhelds/)

*To add a Compaq iPAQ Expansion Pack:*

1. Remove the protective plug that covers the iPAQ Expansion connector on the Pocket PC.
2. Slide the iPAQ H3000 into the Expansion Pack until it clicks into place. The Pocket PC will alert you when the Expansion Pack is ready to be used.



*To view the Expansion Pack properties:*

Press the QMenu button, then tap **Expansion Pack**. If the Expansion Pack is installed properly, the name of the Expansion Pack will appear in the Expansion Pack Properties screen.



*To remove a Compaq iPAQ Expansion Pack:*

1. Press the Expansion Pack lock on the base of the Expansion Pack.
2. Slide the Expansion Pack down and off your iPAQ H3000.



## Compaq iPAQ CF Card Expansion Pack

The optional Compaq iPAQ CF Card Expansion Pack supports Type I and Type II CompactFlash cards. The CompactFlash slot allows you to install storage cards for backup and storage of data and applications. It also allows you to install communication devices such as a LAN adapter or a fax/modem.

### *To insert a CompactFlash card:*

1. Remove the CompactFlash slot cover.

**NOTE:** The CompactFlash slot cover can and should be replaced only when the slot is empty.

2. Push the card, connector-side first into the slot until it stops.



**NOTE:** When you insert a CompactFlash card, your iPAQ H3000 displays a message asking if you want to enable the card you just inserted. You can choose not to do so in order to save battery power. After you enable a card, the only way to disable it, and save power, is to remove the card.

### *To remove a CompactFlash card:*

1. Close all applications on your iPAQ H3000 that have open files on the CompactFlash card.
2. Lever the CompactFlash card out of the slot using a fingernail.

## Guidelines for Using CompactFlash Cards

- Your iPAQ H3000 automatically recognizes a wide range of CompactFlash cards approved for use with ActiveSync. If you are ever instructed to install card-specific iPAQ H3000 drivers provided by a CompactFlash card manufacturer, be sure to install only device drivers specifically designed for the operating system on your iPAQ H3000. If you are unclear about installation instructions, call your CompactFlash card manufacturer for more information.
- Some CompactFlash cards consume large amounts of power. To avoid battery drainage when using a CompactFlash card, connect your iPAQ H3000 to AC power whenever possible.
- If the battery is very low, you should not attempt to save data to a CompactFlash card. This may result in the loss of data. First replace the batteries or connect to AC power.
- Do not turn off your iPAQ H3000 or remove the CompactFlash card when you are in the middle of performing an operation, such as saving data to your CompactFlash card.
- Keep your CompactFlash card in a protective case when not in use to protect it from dirt and moisture.

## The Stylus

Your iPAQ H3000 has a stylus for selecting items and entering information. To use the stylus, press and hold the stylus release button while pulling the stylus upward out of its compartment. To replace the stylus, just insert it back into the compartment, then push it until it clicks into place.



The following actions are available with the stylus:

- **Tap.** Touch the screen once with the stylus to open items and select options.
- **Drag.** Hold the stylus on the screen and drag it across the screen to select text and images. Drag within a list to select multiple items.
- **Tap-and-hold.** Tap and hold the stylus on an item to see a list of actions available for that item. Tap the action you want to perform on the pop-up menu that appears.



**NOTE:** The stylus tip can also be used to press the reset button or set the On/Off switch.



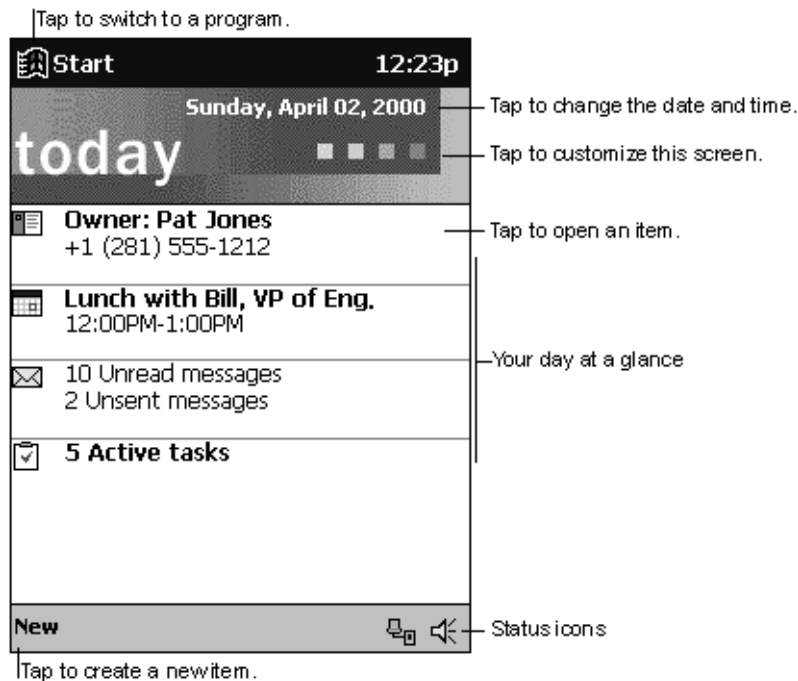

## Today Screen

When you turn on your iPAQ H3000 for the first time each day (or after 4 hours of inactivity), you'll see the Today screen. You can also display it by tapping  then **Today**. On the Today screen, you can see at a glance important information for the day.



You may see the following status icons on the command bar in the Today screen.

<u>Status Icon</u>	<u>Description</u>
	Turns all sounds on and off
	Main battery is charging
	Main battery is low

<u>Status Icon</u>	<u>Description</u>
	Main battery is very low
	External (AC) power source is connected
	Dial-up connection is active
	Direct connection is active





## Programs

You can switch from one program to another by selecting it from the  menu. (You can customize which programs you see on this menu. For information, see “Adjusting Settings,” later in this chapter.) You can also use QStart to switch between programs. See “QStart” later in this chapter.















**NOTE:** Some programs have abbreviated labels for check boxes and drop-down menus. To see the full spelling of an abbreviated label, tap and hold the stylus on the label. Drag the stylus off the label so that the command is not carried out.

**NOTE:** You can also switch to some programs by pressing an application button. Your iPAQ H3000 has four application buttons located on the front of your iPAQ H3000, and the Record button located on the side. The following icons on the buttons on the front of the iPAQ identify the programs they switch to:



Item	Icon	Program
1		Calendar
2		Contacts
3		QMenu
4		QStart

The following table contains a partial list of programs that are on your iPAQ H3000. Look in the Compaq CD and the Extras folder on the ActiveSync CD for additional programs that you can install onto your iPAQ H3000..

Icon	Program	Description
	<b>Calendar</b>	Keep track of your appointments and create meeting requests.
	<b>Contacts</b>	Keep track of your friends and colleagues.
	<b>Inbox</b>	Send and receive e-mail messages.
	<b>Infrared Receive</b>	Receive information from another Windows-powered device.
	<b>Internet Explorer</b>	View Web pages downloaded from your computer or connect to an ISP and browse the Web.
	<b>Microsoft Money</b>	Enter and view transactions and check on your account balances.
	<b>Microsoft Reader</b>	Read or listen to (using Audible) electronic books on your iPAQ.
	<b>Notes</b>	Create handwritten or typed notes, drawings, and recordings.
	<b>Picture Viewer</b>	View bitmap or JPEG images on your iPAQ.
	<b>Pocket Excel</b>	Create new workbooks or view and edit Excel workbooks created on your computer.
	<b>Pocket Word</b>	Create new documents or view and edit Word documents created on your computer.
	<b>QMenu</b>	Activates the QMenu which provides easy-open programs and quick access to activities and the QUtilities.
	<b>QStart</b>	Allows you to quickly access programs.
	<b>Tasks</b>	Keep track of your tasks.

# Navigation Bar and Command Bar

The navigation bar is located at the top of the screen and displays the title of the active program and current time. It also allows you to switch to programs and close screens.

Use the command bar at the bottom of the screen to perform tasks in programs. The command bar includes menu names, buttons, and the input panel button. To create a new item in the current program, tap **New**. To see the name of a button on screen, tap and hold the stylus on the button. Drag the stylus off the button so that the command is not carried out.

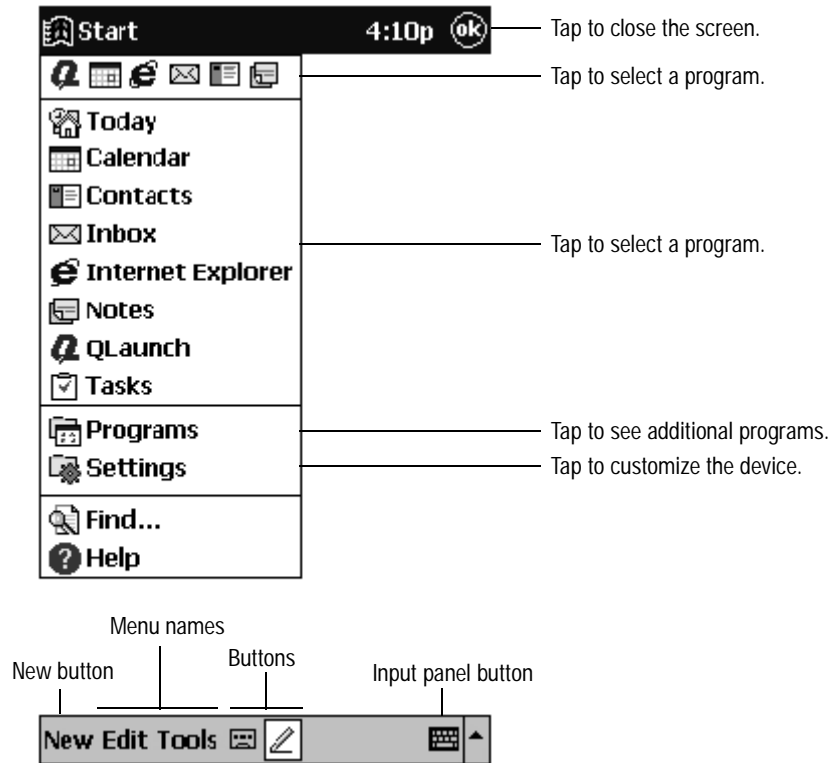

# Pop-up Menu

With pop-up menus, you can quickly choose an action for an item. For example, you can use the pop-up menu in the contact list to quickly delete a contact, make a copy of a contact, or send an e-mail message to a contact. The actions in the pop-up menus vary from program to program. To access a pop-up menu, tap and hold the stylus on the item name that you want to perform the action on. When the menu appears, lift the stylus, and tap the action you want to perform. Or tap anywhere outside the menu to close the menu without performing an action.

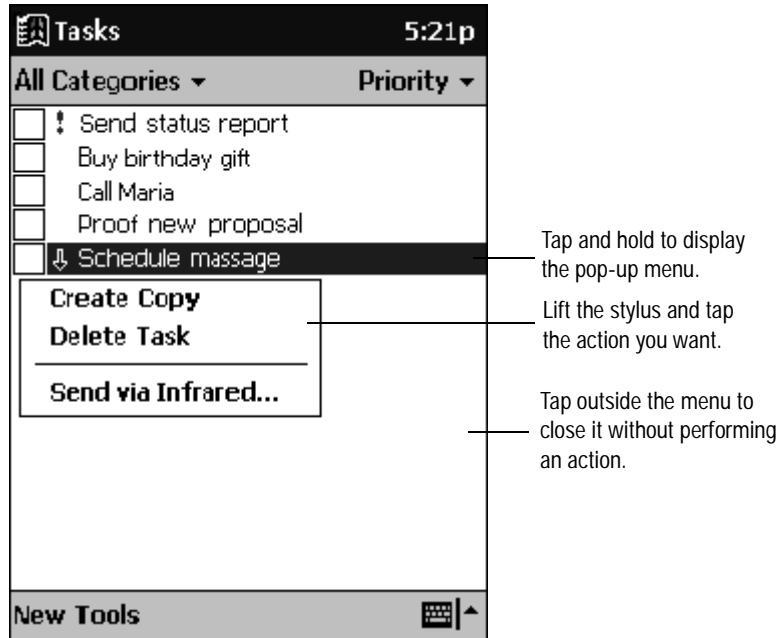

# Notifications

Your iPAQ H3000 reminds you in a variety of ways when you have something to do. For example, if you've set up an appointment in Calendar, a task with a due date in Tasks, or an alarm in Clock, you'll be notified in any of the following ways:

- A message box appears on the screen.
- A sound, which you can specify, plays.
- The green alarm light flashes on your iPAQ H3000.

To choose reminder types and sounds for your iPAQ H3000, tap  then **Settings**. In the **Personal** tab, tap **Sounds & Reminders**. The options you choose here apply throughout your iPAQ H3000.



# Enter Information on Your iPAQ

You have several options for entering new information:

- Enter typed text in the input panel by using the soft keyboard or Character Recognizer.
- Write or draw pictures directly on the screen.
- Speak into your iPAQ H3000 microphone to record a message.
- Synchronize or copy information from your computer to your iPAQ H3000 using ActiveSync. For more information on ActiveSync, see the booklet accompanying the ActiveSync CD or ActiveSync Help on your computer.

## Typing Using the Input Panel

Use the input panel to enter information in any program on your iPAQ H3000. You can either type using the soft keyboard or write using Character Recognizer. In either case, the characters appear as typed text on the screen.

Tap the **Input Panel** button to show or hide the input panel, then tap the arrow next to the **Input Panel** button to see your choices.

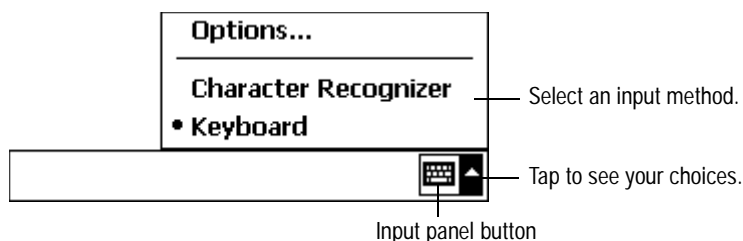

When you use the input panel, your iPAQ H3000 anticipates the word you are typing or writing and displays it above the input panel. When you tap the displayed word, it is inserted into your text at the insertion point. The more you use your iPAQ H3000, the more words it learns to anticipate.



**NOTE:** To change word suggestion options, such as the number of words suggested at one time, tap , **Settings**, **Personal** tab, **Input**, then the **Word Completion** tab.

*To type with the soft keyboard:*

1. Tap the arrow next to the **Input Panel** button then **Keyboard**.
2. Tap the keys with your stylus on the soft keyboard that displays.

*To use Character Recognizer:*

1. Tap the arrow next to the **Input Panel** button then **Character Recognizer**.
2. Write a letter in the box.

When you write a letter, it is converted to typed text that appears on the screen. For specific instructions on using Character Recognizer, see Appendix A.

*To select typed text:*

If you want to edit or format typed text, you must select it first by dragging the stylus across the text you want to select.

You can cut, copy, and paste text by tapping and holding the selected words then tapping an editing command on the pop-up menu, or by tapping the command on the **Edit** menu.

## Writing on the Screen

In any program that accepts writing, such as the Notes program and the **Notes** tab in Calendar, Contacts, and Tasks, you can use your stylus to write directly on the screen. Write the way you do on paper. You can edit and format what you've written and convert the information to text at a later time.

*To write on the screen:*

Tap the **Pen** button to switch to writing mode. This action displays lines on the screen to help you write.

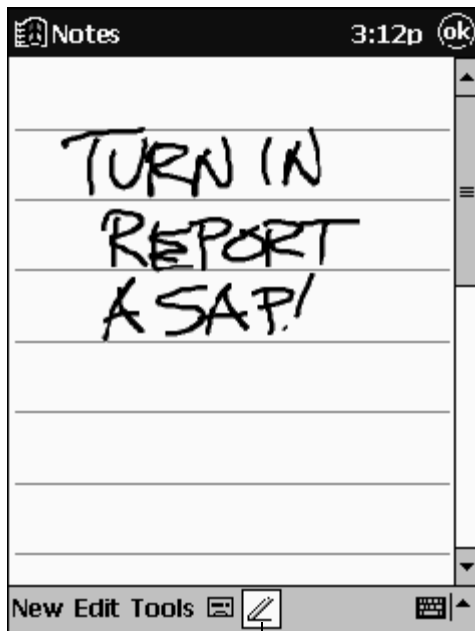

Tap the Pen button and use your stylus like a pen.

**NOTE:** Some programs that accept writing may not have the Pen button. See the documentation for that program to find out how to switch to writing mode.

*To select writing:*

If you want to edit or format writing, you must select it first.

1. Tap and hold the stylus next to the text you want to select until the insertion point appears.
2. Drag the stylus across the text you want to select without lifting the stylus.

If you accidentally write on the screen, tap **Tools** then **Undo** and try again. You can also select text by tapping the **Pen** button to deselect it then dragging the stylus across the screen.

You can cut, copy, and paste written text in the same way you work with typed text: tap and hold the selected words then tap an editing command on the pop-up menu, or tap the command on the **Edit** menu.

*To convert writing to text:*

- Tap **Tools** then **Recognize**.

If you want to convert only certain words, select them before tapping **Recognize** on the **Tools** menu (or tap and hold the selected words then tap **Recognize** on the pop-up menu). If a word is not recognized, it is left as writing.

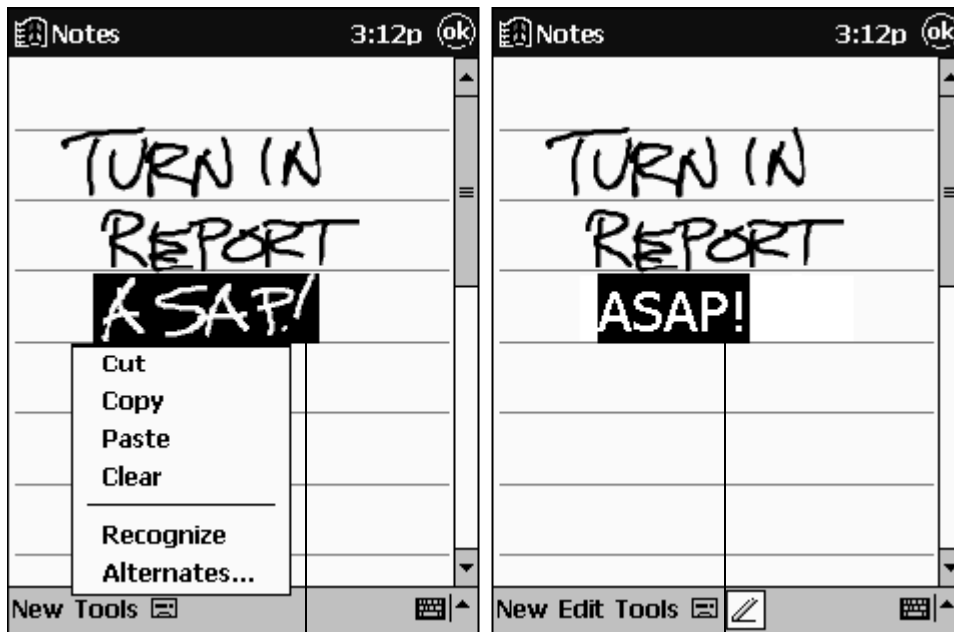

Select the text you want to convert and tap **Recognize** on the pop-up menu.

The writing is turned into text.

If the conversion is incorrect, you can select different words from a list of alternates or return to the original writing. To do so, tap and hold the incorrect word (tap one word at a time). On the pop-up menu, tap **Alternates**. A menu with a list of alternate words appears. Tap the word you want to use, or tap the writing at the top of the menu to return to the original writing.

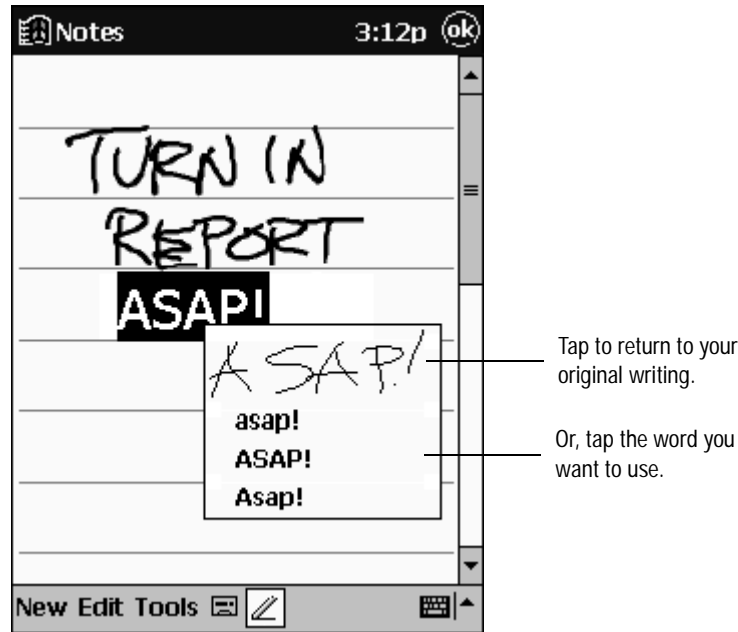

Tips for getting good recognition:

- Write neatly.
- Write on the lines and draw descenders below the line. Write the cross of the “t” and apostrophes below the top line so that they are not confused with the word above. Write periods and commas above the line.
- For better recognition, try increasing the zoom level to 300% using the **Tools** menu.
- Write the letters of a word closely and leave big gaps between words so that your iPAQ H3000 can easily tell where words begin and end.
- Hyphenated words, foreign words that use special characters such as accents, and some punctuation cannot be converted.
- If you add writing to a word to change it (such as changing a “3” to an “8”) after you attempt to recognize the word, the writing you add will not be included if you attempt to recognize the writing again.

## Drawing on the Screen

You can draw on the screen in the same way that you write on the screen. The difference between writing and drawing on the screen is how you select items and how they can be edited. For example, selected drawings can be resized, while writing cannot.

*To create a drawing:*

- Cross three ruled lines on your first stroke. A drawing box appears. Subsequent strokes in or touching the drawing box become part of the drawing. Drawings that do not cross three ruled lines will be treated as writing.

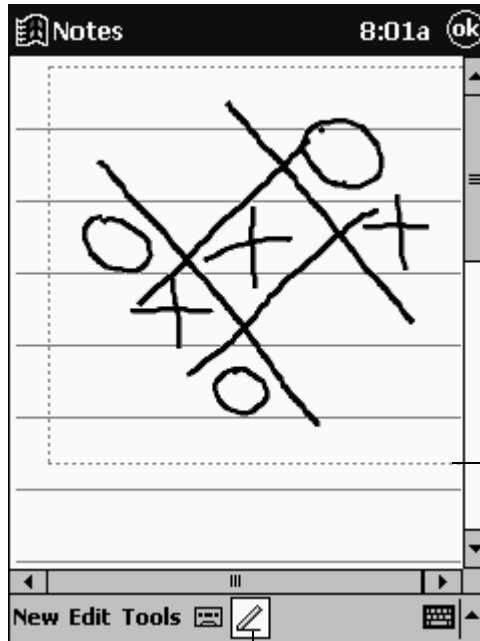

The drawing box indicates the boundaries of the drawing.

Pen button

**NOTE:** You may want to change the zoom level so that you can more easily work on or view your drawing. Tap **Tools** then a zoom level.

*To select a drawing:*

If you want to edit or format a drawing, you must select it first. Tap and hold the stylus on the drawing until the selection handle appears. To select multiple drawings, deselect the **Pen** button then drag to select the drawings you want.

You can cut, copy, and paste selected drawings by tapping and holding the selected drawing then tapping an editing command on the pop-up menu, or by tapping the command on the **Edit** menu. To resize a drawing, make sure the **Pen** button is not selected and drag a selection handle.

## Recording a Message

In any program where you can write or draw on the screen, you can also quickly capture thoughts, reminders, and phone numbers by recording a message. In Calendar, Tasks, and Contacts, you can include a recording in the **Notes** tab. In the Notes program, you can either create a stand-alone recording or include a recording in a written note. If you want to include the recording in a note, open the note first.

*To create a recording:*

1. Hold your iPAQ H3000 so that the microphone is near your mouth or other source of sound.
2. Press and hold the Record button on the side of your iPAQ H3000. You will hear a beep when the program is ready to record.
3. Make your recording while holding down the Record button.
4. Release the Record button to stop recording. Two beeps will sound. The new recording appears in the note list or as an embedded icon.

**NOTE:** You can also make a recording by tapping the **Record** button on the Recording toolbar.

To play a recording, tap it in the list or tap its icon in the note.

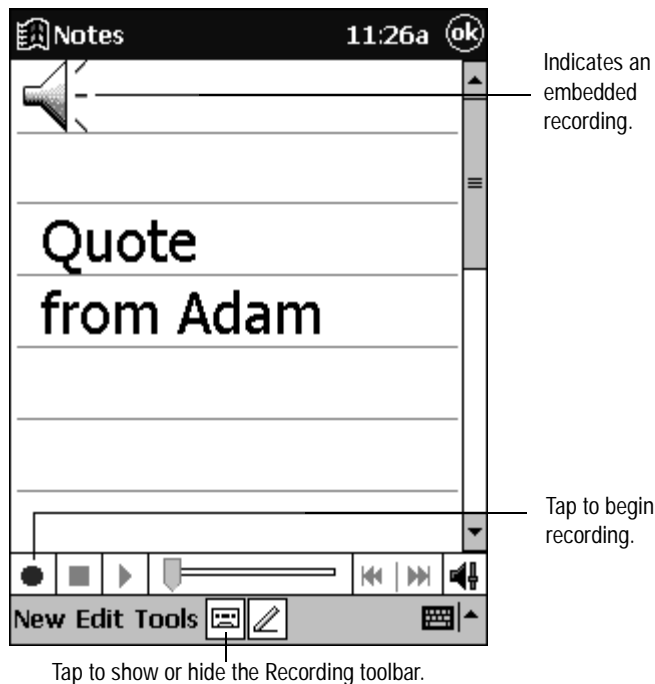

## Find Information

The Find feature on your iPAQ H3000 helps you quickly locate information. On the  menu, tap **Find**. Enter the text you want to find, select a data type, then tap **Go** to start the search.

**NOTE:** To quickly find information that is taking up storage space on your iPAQ H3000, select **Larger than 64 KB** in **Type**.

# Customize Your iPAQ H3000

You can customize your iPAQ H3000 by adjusting iPAQ H3000 settings and installing additional software.

## Adjusting Settings

You can adjust iPAQ H3000 settings to suit the way you work. To see available options, tap , **Settings**, then the **Personal**, **System**, or **Connections** tab located at the bottom of the screen. You can also view settings by pressing the QMenu button, then tapping **Settings**.

You might want to adjust the following:

<u>Item</u>	<u>Description</u>
<b>Align Screen</b>	Adjust the touch screen if it is not responding accurately.
<b>Asset Viewer</b>	Access detailed information about your iPAQ H3000 as well as your owner information.
<b>Backlight</b>	Set the time before the backlight turns off when the iPAQ is idle.
<b>Auto Run</b>	Allow specialized programs stored on a CompactFlash card to begin running automatically as soon as the card is inserted.
<b>Buttons</b>	Associate program buttons with specific programs and adjust the up/down control of your iPAQ Navigator.
<b>Clock</b>	Change the time or set alarms.
<b>Input</b>	Customize the input method and set word completion settings.
<b>Memory</b>	Adjust the allocation of storage and program memory.
<b>Menus</b>	Customize what appears on the  menu and enable a pop-up menu from the <b>New</b> button.
<b>Microphone AGC</b>	Enable or disable Automatic Gain Control function (automatically adjusts the recording volume).
<b>Owner Information</b>	Enter your contact information.
<b>Password</b>	Limit access to your iPAQ H3000.
<b>Power</b>	Maximize battery life.



<u>Item</u>	<u>Description</u>
<b>Regional Settings</b>	Customize the appearance of numbers, currency, times and dates.
<b>Remove Programs</b>	Uninstall a program.
<b>Sounds and Reminders</b>	Customize or turn off sounds.
<b>Today</b>	Customize the information displayed on the Today screen.

## Setting a Password

Password security is provided to help protect against unauthorized use of your iPAQ H3000. For immediate protection, Compaq recommends setting up the password security through the **Password** utility in the **Settings** of your iPAQ H3000 as soon as possible. If set, your login password must be entered each time you turn on your iPAQ H3000.

**NOTE:** Choose a password that's easy to remember. If you forget it, you must perform a full reset to use your iPAQ H3000 again. A full reset restarts your iPAQ H3000 and removes all information that was stored in memory, such as your data files and your system settings.

To set your login password, follow these steps:

1. Tap , **Settings**, then **Password**.
2. Enter a new 4-digit PIN. This number is now your password.
3. Enable the login password by checking the **Require password when device is turned on** box.
4. Save your new settings by tapping **OK**.

Your login password is now set. The login password screen appears each time you turn on your iPAQ H3000.

## Adding or Removing Programs

Programs added to your iPAQ H3000 at the factory are stored in ROM (read-only memory). You cannot remove or modify this software, and you'll never accidentally lose ROM contents. Programs and data files added to your iPAQ H3000 after factory installation are stored in RAM (random access memory). You can install any program created for your iPAQ H3000, as long as your iPAQ H3000 has enough memory. You can also install a program to a CompactFlash card inserted into your iPAQ H3000. The most popular place to find software for your iPAQ H3000 is on the World Wide Web.

## *To add programs*

You'll need to install the appropriate software for your iPAQ H3000 on your computer before installing it on your iPAQ H3000.



1. Download the program to your computer (or insert the CD or disk that contains the program into your computer). You may see a single \*.exe file, a \*.zip file, a Setup.exe file, or several versions of files for different iPAQ H3000 types and processors. Be sure to select the program designed for the Pocket PC and your iPAQ H3000 processor type (StrongARM SA-1110).
2. Read any installation instructions, Read Me files, or documentation that comes with the program. Many programs provide special installation instructions.
3. Connect your iPAQ H3000 and computer.
4. Double-click the \*.exe file.
5. *If the file is an installer*, the installation wizard will begin. Follow the directions on the screen. Once the software has been installed on your computer, the installer will automatically transfer the software to your iPAQ.  
*If the file is not an installer*, you will see an error message stating that the program is valid but it is designed for a different type of computer. You will need to move this file to your iPAQ. If you cannot find any installation instructions for the program in the Read Me file or documentation, use ActiveSync Explore to copy the program file to the Program Files folder on your iPAQ. For more information on copying files using ActiveSync, see ActiveSync Help.

Once installation is complete, tap , **Programs**, then the program icon to switch to it.

## *To add a program to the Start menu:*

Tap , **Settings, Menus**, the **Start Menu** tab, then the check box for the program. If you do not see the program listed, you can either use File Explorer on your iPAQ to move the program to the Start Menu folder or use ActiveSync on the computer to create a shortcut to the program and place the shortcut in the Start Menu folder.

### **Using File Explorer on your iPAQ:**

1. Tap , **Programs, File Explorer**, and locate the program (tap the folder list, labeled **My Documents** by default, then **My Device** to see a list of all folders on your iPAQ).
2. Tap and hold the program and tap **Cut** on the pop-up menu.
3. Open the Start Menu folder located in the Windows folder, tap and hold a blank area of the window, and tap **Paste** on the pop-up menu. The program will now appear on the  menu. For more information on using File Explorer, see "Find and Organize Information," earlier in this chapter.

### **Using ActiveSync on the computer:**

1. Use the Explorer in ActiveSync to explore your iPAQ files and locate the program.
2. Right-click the program, then click **Create Shortcut**.
3. Move the shortcut to the Start Menu folder in the Windows folder. The shortcut now appears on the  menu. For more information, see ActiveSync Help.

### *To remove programs:*

1. Tap  then **Settings**.
2. Tap **Remove Programs** on the **System** tab.
3. Use File Explorer on your iPAQ to locate the program if the program does not appear as an installed program.
4. Tap and hold the program.
5. Tap **Delete** on the pop-up menu.

## **Power**

When you are working with your iPAQ H3000 and using battery power, you can monitor the charge held in the battery by using the Power window. To conserve battery power, your iPAQ H3000 automatically powers off whenever it is idle for a continuous period of time. If you are running on battery power, you can conserve charge if you shorten the idle time before your iPAQ H3000 automatically powers off.

*To display the Power control panel:*

Tap , **Settings, System**, then **Power**.

**NOTE:** If the battery is low on charge, the battery icon appears on the command bar on the Today screen. Tap the battery icon to display the Power control panel.

**NOTE:** If the battery gets very low, your iPAQ H3000 displays a warning message. If this occurs, save any unsaved data you are working on, perform a synchronization with your computer, then turn off your iPAQ H3000. Don't try to restart your iPAQ H3000 until you have connected to external power. If your iPAQ H3000 shuts down, you still have about 24 hours to recharge the battery before you lose the data on your iPAQ H3000.

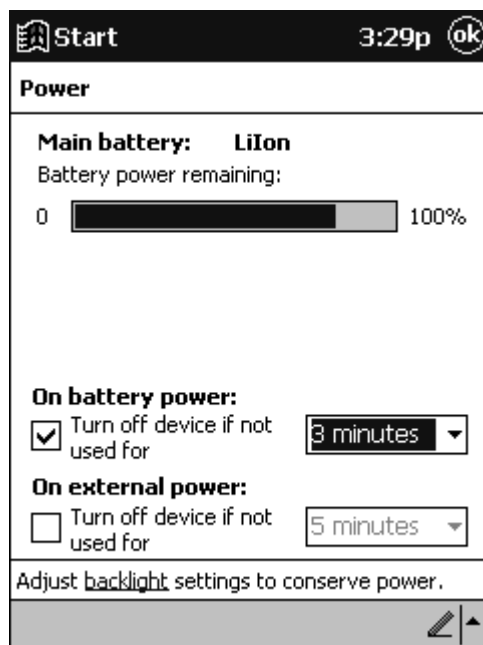

The Power control panel only shows the battery charge level if you are using the battery. If you have connected the AC adapter, the window shows the recharging status.

*To set the power off timer:*

1. Tap , **Settings, System**, then **Power**.
2. Use the drop down menus to set the idle intervals before your iPAQ automatically powers off.

**NOTE:** If you are playing an audio file on your iPAQ H3000 under battery power, the display will automatically turn off after one minute if there has been no input to your iPAQ H3000. The display will turn back on once the audio file has finished playing. This power saving feature is not adjustable.

## Adjusting the Backlight

The iPAQ H3000 Pocket PC features a built-in light sensor that allows the iPAQ to automatically adjust the backlight brightness according to the ambient lighting level. The backlight on your iPAQ H3000 lets you view text and graphics clearly whether you're indoors or outdoors, in a dim study or at a brightly lit worksite. You can also set the backlight brightness manually.

There are two ways to change the backlight setting:

- Press and hold the Power button for one second to toggle on or off the backlight.
- Press the QMenu button, and tap **Backlight**. Then deselect **Automatic**, and select the desired brightness level.
- Tap , **Settings, System, Backlight, Brightness**. Then deselect **Automatic**, and select the desired brightness level.

To set the iPAQ H3000 to automatic, press the QMenu button, then tap **Backlight, Automatic**.



*To adjust the backlight time-out:*

1. Press the QMenu button, then tap **Backlight**, **Battery Power**, or **External Power**.
2. Use the drop-down menus to set the amount of idle time before the backlight turns off when your iPAQ is using battery power and external power.

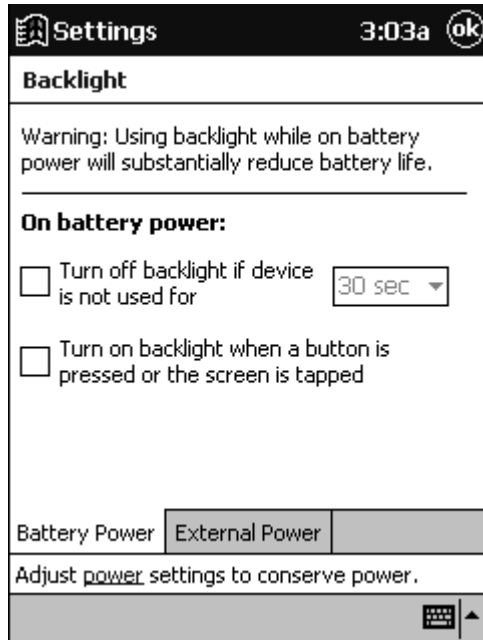

## QStart

**QStart** allows you to quickly access programs on your iPAQ Pocket PC. There are two ways to access the **QStart**:

- Press the QStart button.
- Tap , **Programs** then **QStart**.

To open a program, select a category from the pop-up menu at the bottom of the screen, then tap the program icon. To customize the appearance of the **QStart** categories, tap **Tools**. You can create a new category or add or remove applications from an existing category.

# QUtilities and QMenu

Customizing your iPAQ Pocket PC is both convenient and easy when you use the **QMenu** and the **QUtilities**. The **QMenu** and **QUtilities** let you quickly access several important setting controls. The **QMenu** also lets you switch between, or close, open applications.

The **QUtilities** are located on the **QMenu**. There are four ways to access the **QMenu**:

- Press the QMenu button.
- Tap the **Q** icon on the command bar in QStart.
- Tap the **Q** icon on the command bar on the Today screen.
- Tap , then **QMenu**.

If you want to remove the **Q** icon from your command bar, tap **Exit** on the **QMenu**. To restore the **Q** icon, tap , then **QMenu**.

To change which items appear on the **QMenu**, press the QMenu button, then tap **QUtilities**, **QMenu**. Any items that you select will appear on the **QMenu**.

## Task Management

The **QMenu** allows you to close or switch among tasks on your iPAQ H3000. You can close the program that is currently active by tapping **Close active task**. Close all the open programs on your iPAQ H3000 by tapping **Close all tasks**.

**NOTE:** When you close a task, all unsaved data in that task is lost.

Below these two options is a list of running tasks. To switch among running tasks, tap the name of the task you want to go to.

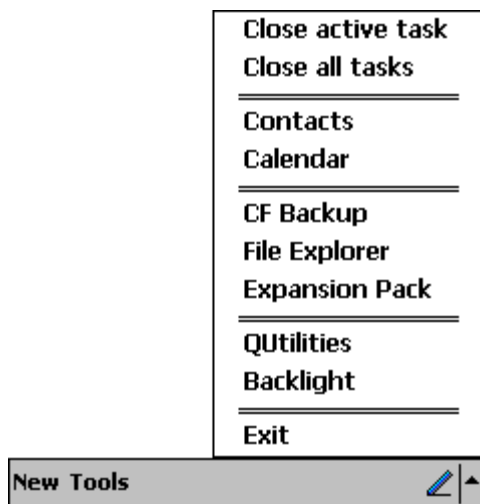

## File Explorer

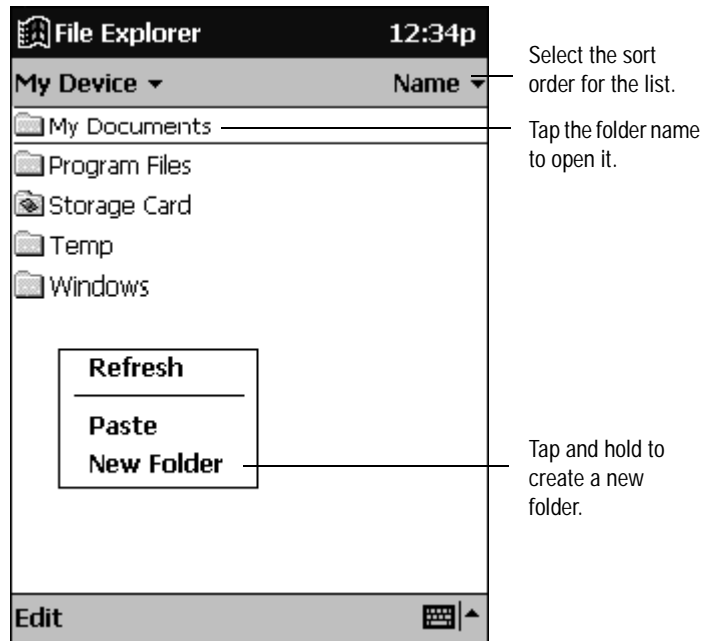

You can use the File Explorer to find files on your iPAQ and to organize these files into folders. Press the QMenu button, then tap **File Explorer**.



**NOTE:** You can move files in File Explorer by tapping and holding the item you want to move then tapping **Cut** or **Copy** and **Paste** on the pop-up menu.

## Self Test

The **Self Test** utility within **QUtilities** activates a debugging and system diagnostic tool. Use this tool to verify any problems that you may have experienced on your iPAQ.

1. Press the QMenu button, then tap **Close all tasks** to close all active programs.
2. *If you have enabled password protection at power-on*, disable this by tapping , **Settings**, then **Password**. Enter your 4-digit PIN, then deselect the **Require password** check box.  
*If you have enabled display owner identification at power-on*, disable this by tapping , **Settings**, then **Owner Information**. Deselect the **Show information when device is turned on** check box.



3. Press the QMenu button, then tap **QUtilities**, then **Self Test**.
4. Tap the check boxes to select the items you want to test, then tap **Next**.

**NOTE:** The "IR transfer" test item is an internal infrared functionality test. You do not need to set up another IR iPAQ to test this item.

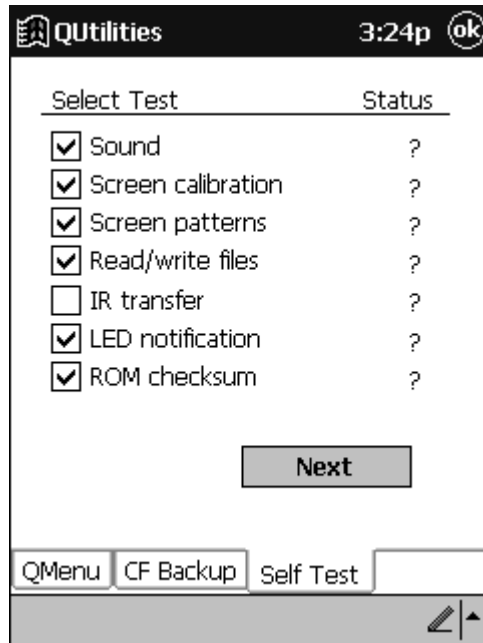

5. Tap **Start**. Your iPAQ will reset (unless you have disabled this option), and the test will start automatically. Follow the instructions to complete the test. When **Self Test** finishes running, it displays the result of each test item.
6. Tap **Finish**. You can also choose to save the results as a log file. This is stored in **My Documents** on your iPAQ.
7. Tap **OK** to exit.
8. Reset your password and owner information settings.

*To read the Self Test log file on your computer:*

1. Connect your iPAQ to your computer, then use ActiveSync to copy the file from **My Documents** on your iPAQ, to your computer.
2. Open the **DIAGNOSTICS.log** file in **WordPad** on your computer.

## Controlling Volume

The **Volume** utility provides an easy way to adjust the volume of your iPAQ H3000.

1. Press the QMenu button, then tap **Volume**.

- or -

Tap , **Settings**, **System**, then **Sounds & Reminders**.

2. Adjust the volume level on the slider.
3. Tap **OK** to save the new setting.

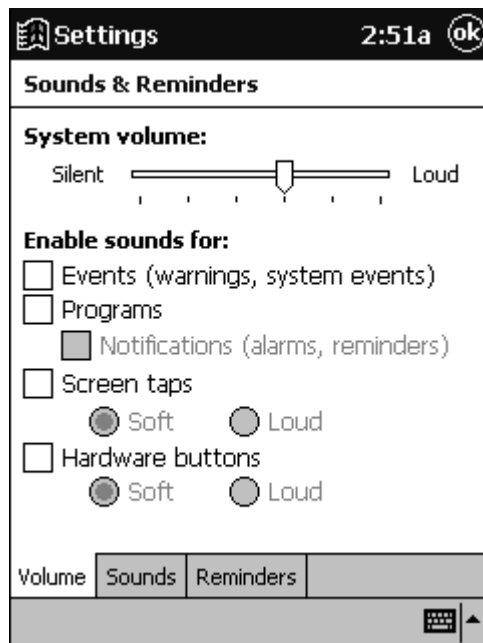

## Backup and Restore Data

To avoid losing your data in the event that your iPAQ Pocket PC is lost, stolen, or becomes defective, Compaq recommends periodic backups to the computer or a CompactFlash card. Depending on your usage, you may want to perform a backup as often as once a day. You can back up and restore your iPAQ's data using the following utilities:

- **ActiveSync Backup/Restore.** Use this ActiveSync utility to periodically back up your iPAQ's data onto your computer's hard drive. You can manually back up data or set this utility to back up automatically each time you connect to your Pocket PC. For more information, see ActiveSync Help on your computer.
- **CF Backup.** This utility lets you back up and restore your entire Pocket PC memory contents to a CompactFlash storage card (purchased separately). You can then carry a CompactFlash card-based copy of your data with you at all times for quick retrieval.

## Backing up Data to a CF Card

Each time you use the **CF Backup** utility, your data files, databases, preferences, Active-Sync system data, and applications are copied to the CompactFlash storage card. The sub-directories on your iPAQ H3000 are also duplicated on the storage card.

**NOTE:** CF Backup is designed for use with CompactFlash storage cards that are approved by Microsoft as Windows CE compatible. You should use a card at least as big as your iPAQ H3000's RAM (Random Access Memory) size, e.g., 16 or 24 MB. For information on ordering a CompactFlash storage card, see the *Accessories Information* included in the shipping box. For a list of other Compaq-tested CompactFlash cards, visit the Compaq iPAQ H3000 home page at [www.compaq.com/products/handhelds](http://www.compaq.com/products/handhelds).

*To perform a backup:*

1. Connect to external power or, tap , **Settings, System**, then **Power** to verify that the battery has a charge rating of 20% or greater.
2. Install the optional Compaq iPAQ CF Card Expansion Pack and CompactFlash storage card on your iPAQ, as described earlier this chapter.
3. Press the QMenu button, then tap **Close all tasks**, to close all active programs.
4. Press the QMenu button, then tap **QUtilities, CF Backup**, then **Backup**. The screen displays a list of all the items that will be backed up, so it is easy to identify the data and size that is saved to the CompactFlash storage card.

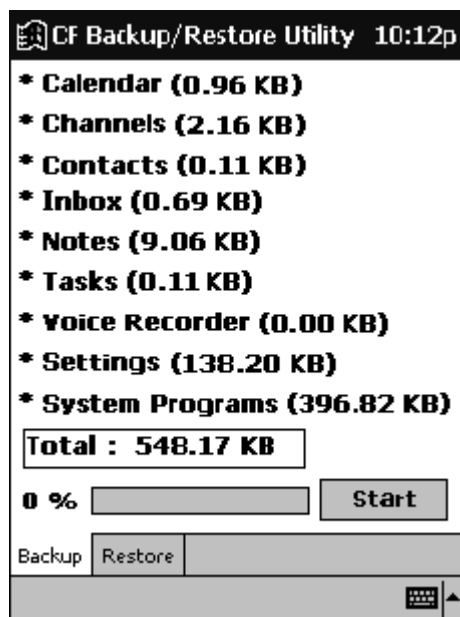

5. Tap the **Start** button to begin the backup process. A status bar reports the data activity until the function is complete.

**CAUTION:** Do not remove the CF card, or turn off the unit during backup. Data loss can result

6. When backup is complete, remove the CompactFlash storage card and keep it close for easy retrieval.

*To restore a backup onto your iPAQ Pocket PC:*

1. Install the optional Compaq iPAQ CF Card Expansion Pack and CompactFlash storage card on your iPAQ.
2. Turn on your iPAQ.
3. Press the QMenu button, then tap **Close all tasks** to close all active programs.
4. Press the QMenu button, then tap **QUtilities, CF Backup** tab.
5. Tap **Restore**.
6. Tap the **Start** button to begin the restore process. A status bar reports the data activity until the function is complete.

**CAUTION:** Do not remove the CF card, or turn off the unit during restore. Data loss can result.

7. Press the reset button to restart your iPAQ when the restore process is complete.

# chapter 3

## MICROSOFT ACTIVESYNC

Using Microsoft ActiveSync, you can *synchronize* the information on your computer with the information on your iPAQ H3000 Pocket PC. Synchronization compares the data on your iPAQ H3000 Pocket PC with your computer and updates both computers with the most recent information. For example:

- Keep Pocket Outlook data up-to-date by synchronizing your iPAQ H3000 with your choice of Microsoft Outlook, Microsoft Schedule+, or Microsoft Exchange on your computer.
- Synchronize Microsoft Word and Microsoft Excel documents between your iPAQ H3000 and computer. Your files are automatically converted to the correct format.

**NOTE:** By default, ActiveSync does not automatically synchronize all types of information, for example, e-mail messages. Use ActiveSync options to turn synchronization on and off for specific information types.

With ActiveSync, you can also:

- Back up and restore your iPAQ H3000 data.
- Copy (rather than synchronize) files between your iPAQ H3000 and computer.
- Control when synchronization occurs by selecting a synchronization mode. For example, you can synchronize continually while the iPAQ H3000 is in the cradle or only when you choose the synchronize command.
- Select which information types are synchronized and control how much data is synchronized. For example, you can choose how many weeks of past appointments you want synchronized.

For information on installing ActiveSync, see the booklet accompanying the ActiveSync CD. For information on using ActiveSync, see ActiveSync Help on the computer.



# *chapter 4*

## MICROSOFT POCKET OUTLOOK

Microsoft Pocket Outlook® includes Calendar, Contacts, Tasks, Inbox, and Notes. You can use these programs individually or together. For example, e-mail addresses stored in Contacts can be used to address e-mail messages in Inbox.

Using ActiveSync, you can synchronize information in Microsoft Outlook, Microsoft Schedule+, or Microsoft Exchange on your computer with your iPAQ H3000. Each time you synchronize, ActiveSync compares the changes you made on your iPAQ H3000 and computer and updates both with the latest information. For information on using ActiveSync, see ActiveSync Help on the computer.

You can switch to any of these programs by tapping them on the  menu.

# Calendar: Scheduling Appointments and Meetings

Use Calendar to schedule appointments, including meetings and other events. You can check your appointments in one of several views (Agenda, Day, Week, Month, and Year) and easily switch views by using the **View** menu.

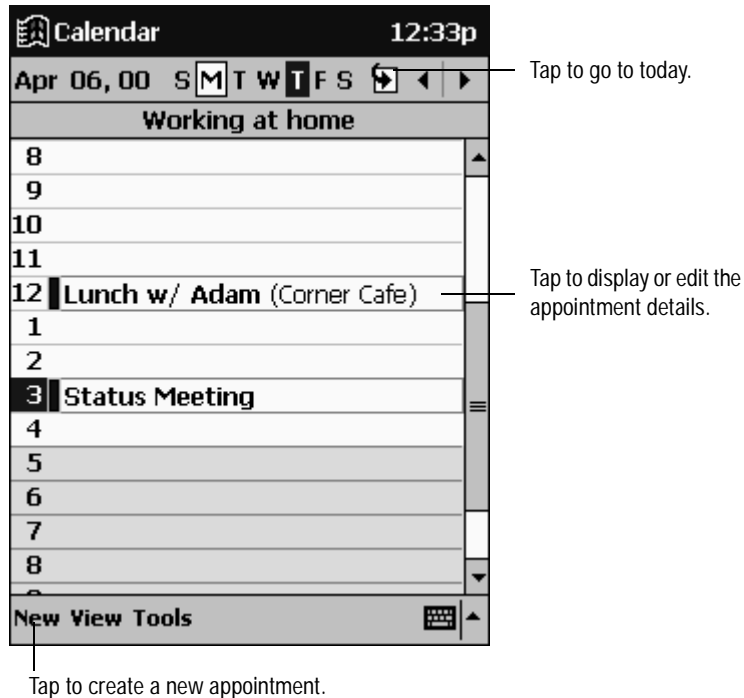

**NOTE:** You can customize the Calendar display, such as changing the first day of the week, by tapping **Options** on the **Tools** menu.

*To create an appointment:*

1. Tap the desired date and time for the appointment if you are in Day or Week view.
2. Tap **New**.



Tap to return to the calendar (the appointment is saved automatically).

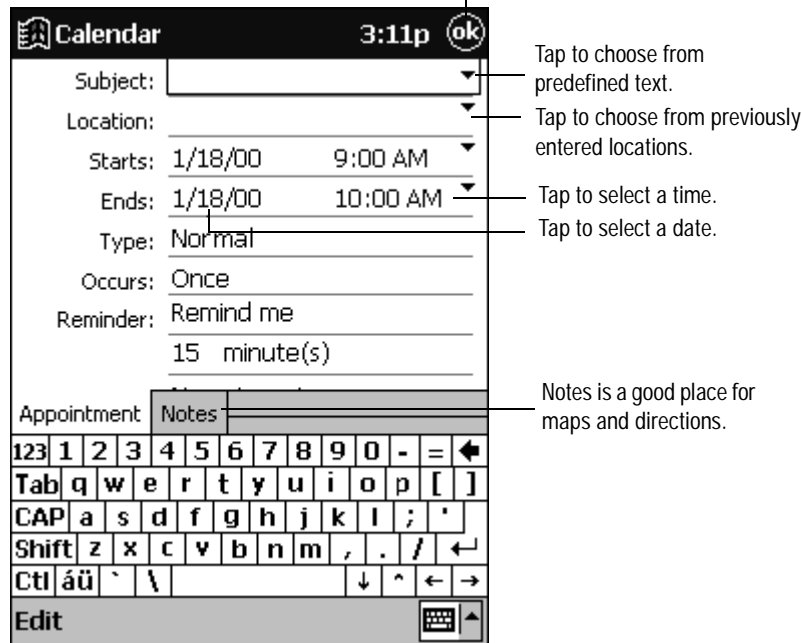

3. Enter a description and a location using the input panel. Tap first to select the field.
4. Tap the date and time to change them, if needed.
5. Enter other desired information. You will need to hide the input panel to see all available fields.
6. Tap the **Notes** tab to add notes. You can enter text, draw, or create a recording. For more information on creating notes, see “Notes: Capturing Thoughts and Ideas,” later in this chapter.
7. Tap **OK** to return to the calendar when finished.

**NOTE:** If you select **Remind me** in an appointment, your iPAQ H3000 will remind you according to the options set in **Settings, Personal tab, Sounds & Reminders**.

## Using the Summary Screen

When you tap an appointment in Calendar, a summary screen is displayed. Tap the top portion of the summary screen to change the appointment.

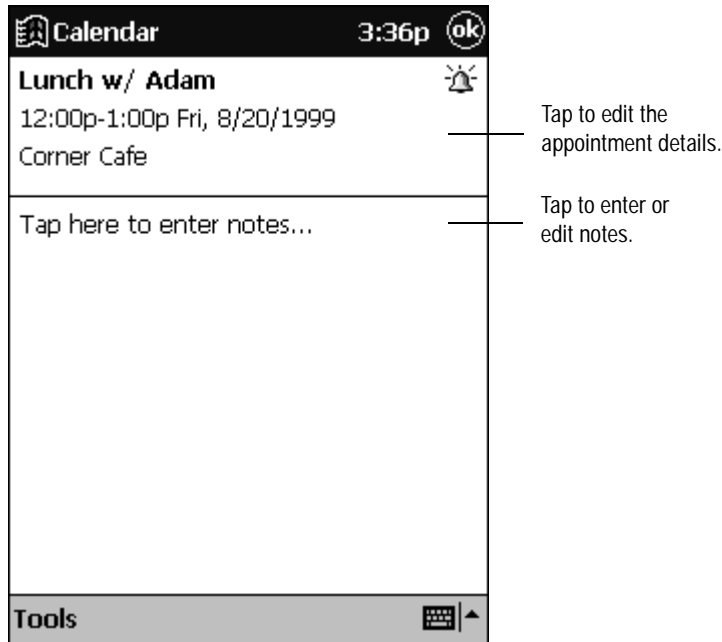

## Creating Meeting Requests

You can use Calendar to set up meetings with users of Outlook, Pocket Outlook, or Schedule+. The meeting notice will be created automatically and sent either when you synchronize Inbox or when you connect to your e-mail server. Indicate how you want meeting requests sent by tapping **Tools** then **Options**. If you send and receive e-mail messages through ActiveSync, select **ActiveSync**.

*To schedule a meeting:*

1. Create an appointment.
2. Tap the **Input Panel** button to hide the input panel, then tap **Attendees** in the appointment details.
3. Select the meeting attendees from the list of e-mail addresses you've entered in Contacts.

The meeting notice is created automatically and placed in the Outbox folder. For more information on sending and receiving meeting requests, see Calendar Help and Inbox Help on the iPAQ H3000.

## Contacts: Tracking Friends and Colleagues

Contacts maintains a list of your friends and colleagues so that you can easily find the information you're looking for, whether you're at home or on the road. Using the iPAQ H3000 Fast Infrared (Fast IR) port, you can quickly share Contacts information with other Windows-powered device users.

Select the category of contacts you want displayed in the list.

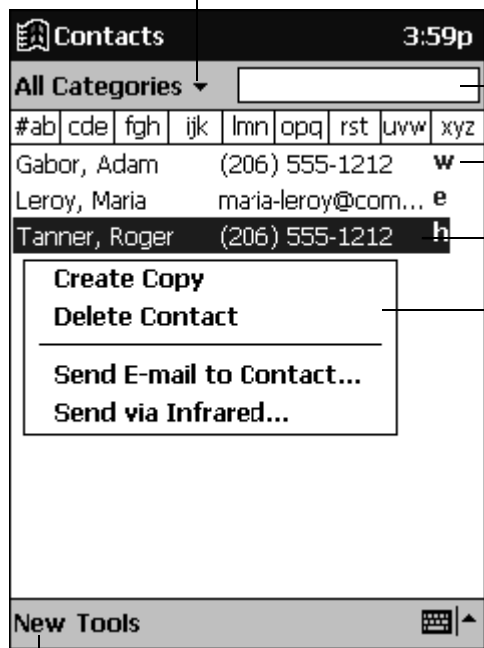

Tap and enter part of a name to quickly find it in the list.

Tap to see additional phone numbers and e-mail addresses.

Tap to display or edit the contact details.

Tap and hold to display a pop-up menu of actions.

Tap to create a new contact.

**NOTE:** To change the way information is displayed in the list, tap **Tools** then **Options**.

*To create a contact:*

1. Tap **New**.

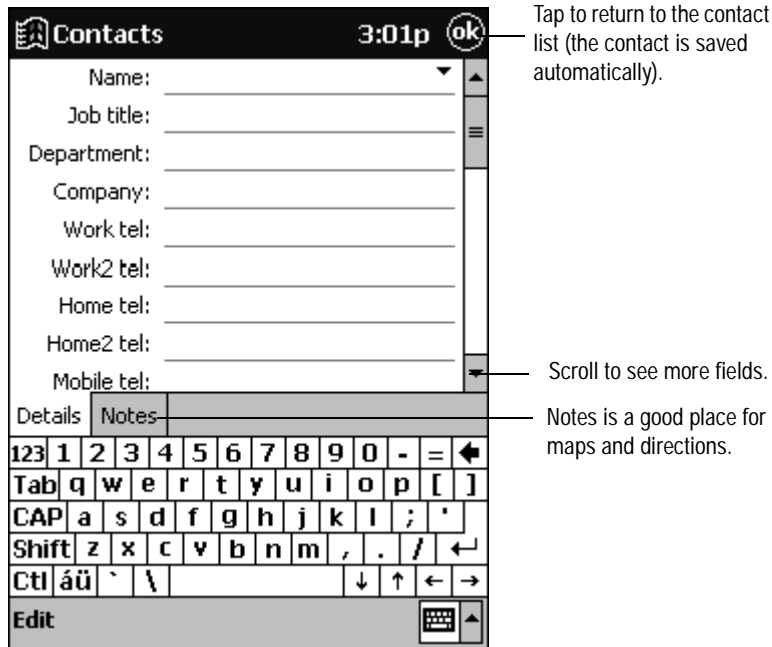

2. Enter a name and other contact information using the input panel. You will need to scroll down to see all available fields.
3. Scroll to and tap **Categories** and select a category from the list to assign the contact to a category. In the contact list, you can display contacts by category.
4. Tap the **Notes** tab to add notes. You can enter text, draw, or create a recording. For more information on creating notes, see “Notes: Capturing Thoughts and Ideas,” later in this chapter.
5. Tap **OK** to return to the contact list when finished.

## Using the Summary Screen

When you tap a contact in the contact list, a summary screen is displayed.

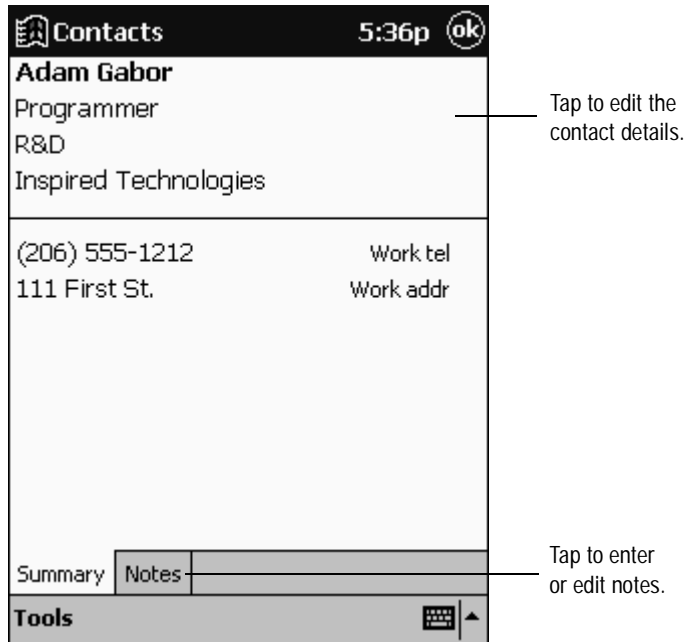

## Tasks: Keeping a To Do List

Use Tasks to keep track of what you have to do. In the task list, overdue tasks are displayed in bold (and in red on the color iPAQ H3000 and 3000).

Select the category of tasks you want displayed in the list.

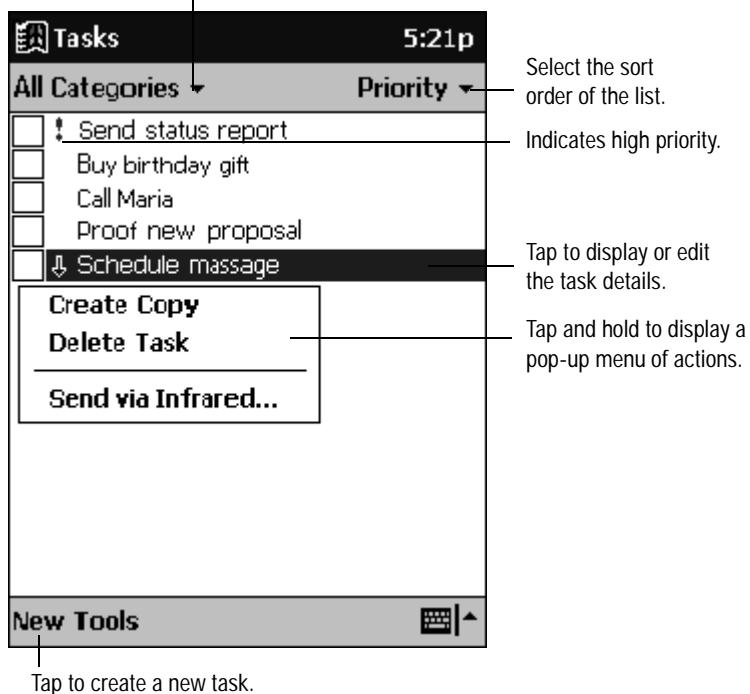

**NOTE:** To change the way information is displayed in the list, tap **Tools** then **Options**.

*To create a task:*

1. Tap **New**.

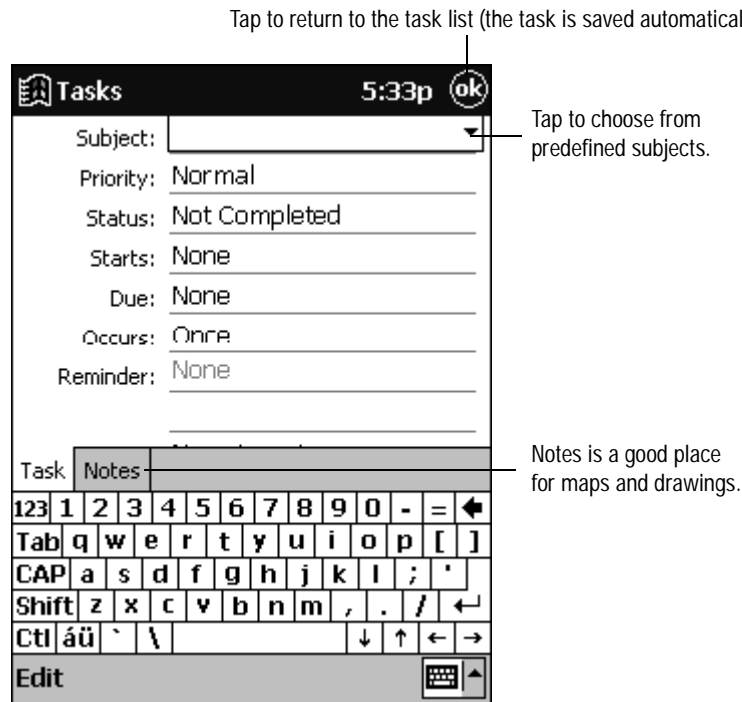

2. Enter a description using the input panel.
3. Enter a start date and due date or enter other information by first tapping the field. If the input panel is open, you will need to hide it to see all available fields.
4. Tap **Categories** and select a category from the list to assign the task to a category. In the task list, you can display tasks by category.
5. Tap the **Notes** tab to add notes. You can enter text, draw, or create a recording. For more information on creating notes, see “Notes: Capturing Thoughts and Ideas,” later in this chapter.
6. Tap **OK** to return to the task list when finished.

**NOTE:** To quickly create a task with only a subject, tap **Entry Bar** on the **Tools** menu. Then, tap **Tap here to add a new task** and enter your task information.

# Using the Summary Screen

When you tap a task in the task list, a summary screen is displayed.

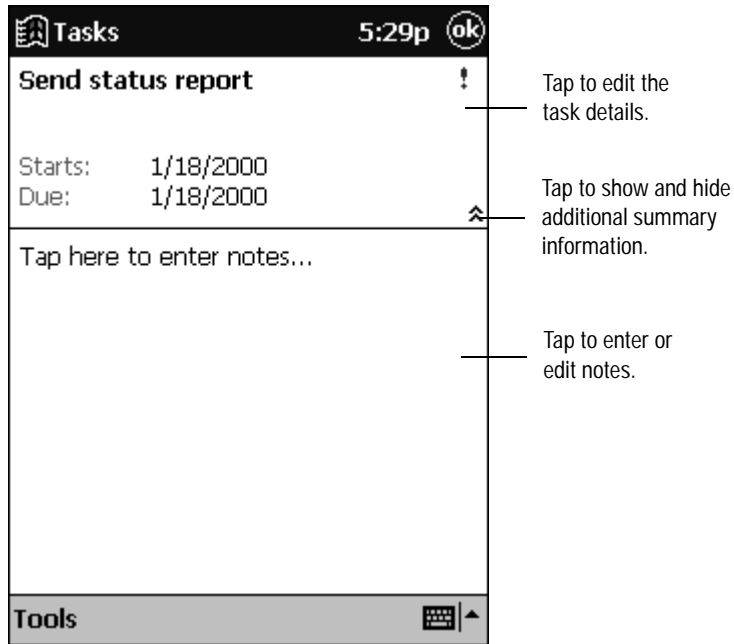

# Notes: Capturing Thoughts and Ideas

Quickly capture thoughts, reminders, ideas, drawings, and phone numbers with Notes. You can create a written note or a recording. You can also include a recording in a note. If a note is open when you create the recording, it will be included in the note as an icon. If the note list is displayed, it will be created as a stand-alone recording.

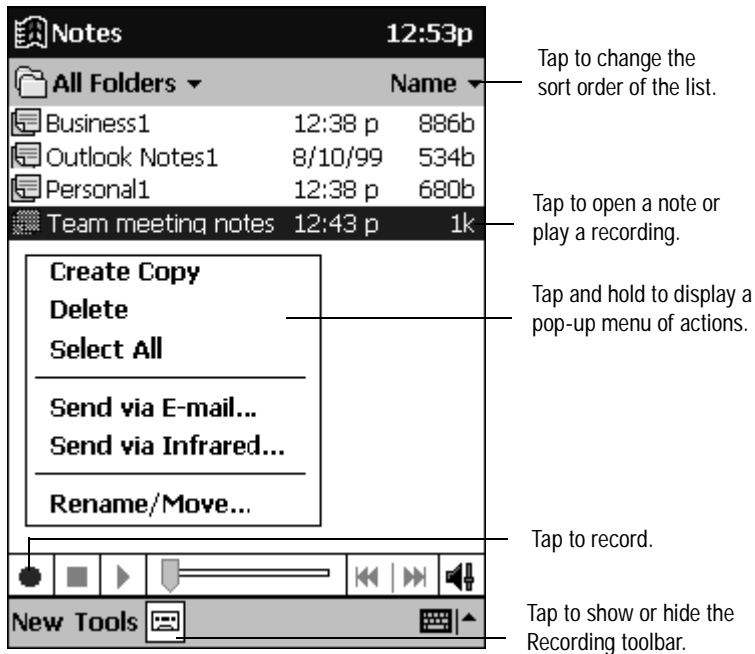



To create a note:

1. Tap **New**.
2. Create your note by writing, drawing, typing, and recording. For more information about using the input panel, writing and drawing on the screen, and creating recordings, see Chapter 2.

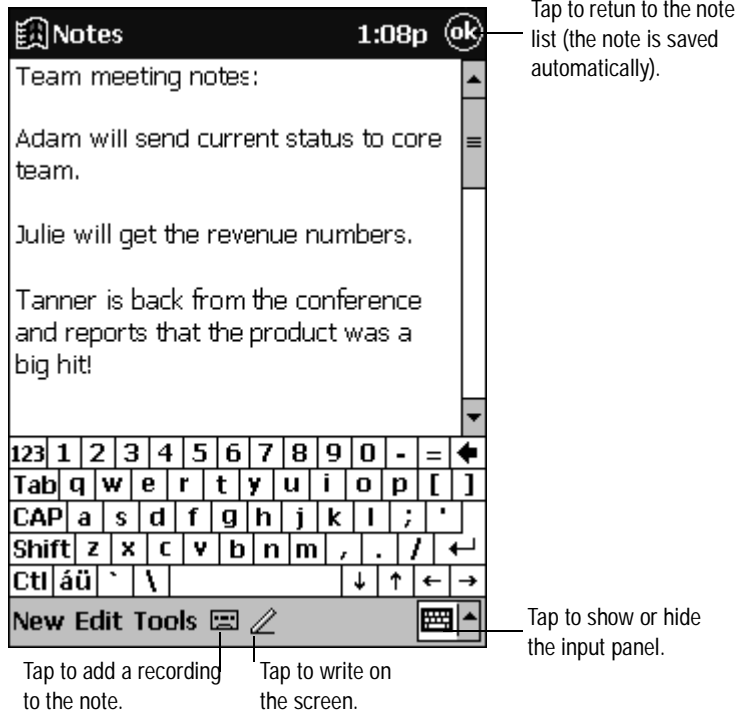

# Inbox: Sending and Receiving E-mail Messages

Use Inbox to send and receive e-mail messages in either of these ways:

1. Synchronize e-mail messages with Microsoft Exchange or Outlook on your computer.
2. Send and receive e-mail messages by connecting directly to an e-mail server through an Internet service provider (ISP) or a network.

## Synchronizing E-mail Messages

E-mail messages can be synchronized as part of the general synchronization process. First, enable Inbox synchronization in ActiveSync options. For information on enabling Inbox synchronization, see ActiveSync Help on the computer. During synchronization:

- E-mail messages are copied from the Inbox folder of Exchange or Outlook on your computer to the Inbox folder on your iPAQ H3000. The e-mail messages on the two computers are linked, so when you delete an e-mail message on your iPAQ H3000, it's also deleted from your computer the next time you synchronize.
- E-mail messages in the Outbox folder on your iPAQ H3000 are transferred to Exchange or Outlook, then sent from those programs.

**NOTE:** You can also synchronize e-mail messages with your computer from a remote location. For more information, see Chapter 7.

## Connecting Directly to an E-mail Server

In addition to synchronizing e-mail messages with your computer, you can send and receive e-mail messages by connecting to an e-mail server using an optional modem or network card connected to your iPAQ H3000. You'll need to set up a remote connection to a network or an ISP, and a connection to your e-mail server. For more information, see Chapter 7.

When you connect to the e-mail server, new messages are downloaded to the iPAQ H3000 Inbox folder, messages in the iPAQ H3000 Outbox folder are sent, and messages that have been deleted on the e-mail server are removed from the iPAQ H3000 Inbox.

Messages that you receive directly from an e-mail server are linked to your e-mail server rather than your computer. When you delete a message on your iPAQ H3000, it's also deleted from the e-mail server the next time you connect.

You can work online or offline. When working online, you read and respond to messages while connected to the e-mail server. Messages are sent as soon as you tap **Send**, which saves space on your iPAQ H3000.

When working offline, once you've downloaded new message headers or partial messages, you can disconnect from the e-mail server then decide which messages to download completely. The next time you connect, Inbox downloads the complete messages you've marked for retrieval and sends the messages you've composed.

# Using the Message List

Messages you receive are displayed in the message list. By default, the most recently received messages are displayed first in the list.



When you receive a message, tap it in the list to open it. Unread messages are displayed in bold.

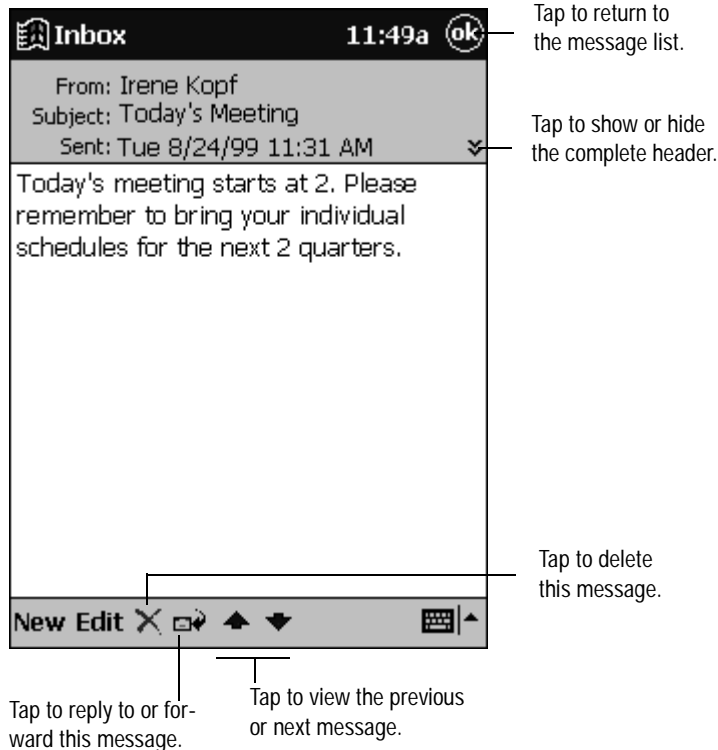

When you connect to your e-mail server or synchronize with your computer, Inbox downloads only the first 100 lines of each new message by default. No e-mail attachments are downloaded. The original messages remain on the e-mail server or your computer.

You can mark the messages that you want to retrieve in their entirety the next time you synchronize or connect to your e-mail server. In the message list, tap and hold the message you want to retrieve. On the pop-up menu, tap **Get Full Copy**. The icons in the Inbox message list give you visual indications of message status.

You'll need to download a full message before you can view its attachments. Attachments appear as icons in a window pane at the bottom of the message. Tapping an attachment icon opens the attachment if it has been fully downloaded or marks it for download the next time you synchronize or connect to your e-mail server.

You specify your downloading preferences when you set up the service or select your synchronization options. You can change them at any time:

- Change options for Inbox synchronization using ActiveSync options. For more information, see ActiveSync Help.
- Change options for direct e-mail server connections in Inbox on your iPAQ H3000. Tap **Tools** then tap **Options**. On the **Service** tab, tap the service you want to change.

# Composing E-mail Messages

*To compose an e-mail message:*

1. Tap **New**.
2. Enter an e-mail address in **To**, or select a name from the contact list by tapping the **Address Book** button.  
All e-mail addresses entered in the e-mail fields in Contacts appear in the Address Book.

Tap to send the message.

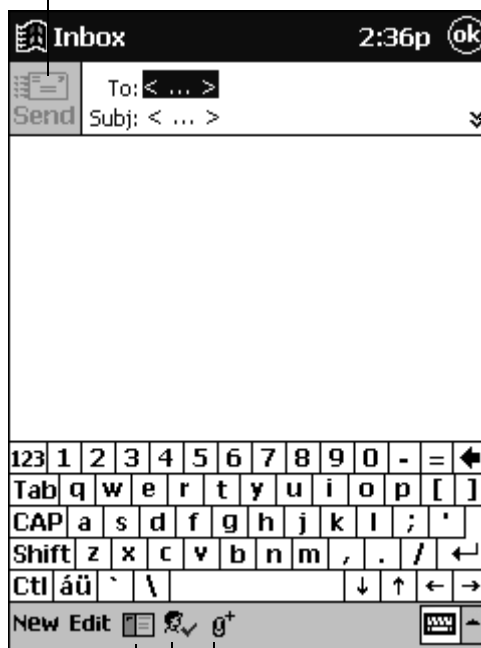

Tap to show or hide the complete header.

Tap to attach a file.

Tap to check names in the To, Cc, and Bcc boxes with names in Contacts and/or an online address book.

Tap to display the address book.

3. Compose your message.
4. Tap **Send** when you've finished the message.

The message is placed in the Outbox folder on your iPAQ H3000 and will be delivered in one of two ways:

- They are transferred to the Outbox folder in Exchange or Outlook on your computer and sent the next time you synchronize.
- They are transferred to your e-mail server the next time you connect. In Inbox, make sure the appropriate service is selected on the **Services** menu. Then tap the **Connect** button (or **Connect** on the **Services** menu).

## Managing E-mail Messages and Folders

By default, messages are displayed in one of four folders for each service you've created: Inbox, Deleted (local), Outbox, and Sent. The Deleted folder contains messages that have been deleted on the iPAQ H3000. If you are using IMAP4, you may see a Deleted Items folder. This folder is for messages deleted on the e-mail server. The behavior of the Deleted and Sent folders depends on the options you have chosen. In the message list, tap **Tools** then **Options**. On the **Message** tab, select your options.

If you want to organize messages into additional folders, tap **Tools**, then **New Folder** to create new folders. To move or copy a message to another folder, in the message list, tap and hold the message then tap **Move to** or **Copy to** on the pop-up menu.

### *Folder behavior with ActiveSync*

If you move e-mail messages into a folder you create, the link is broken between these e-mail messages and their copies on the computer. When you synchronize next, the e-mail messages in the folder you created will not be synchronized. In addition, e-mail messages that are missing from the iPAQ H3000 Inbox folder will be deleted from the Inbox folder on the computer so that both Inbox folders match. This prevents you from getting duplicate copies of an e-mail message, but it also means that you will no longer have access to the e-mail messages you move out of Inbox except from the iPAQ H3000.

### *Folder behavior with a direct connection to an e-mail server*

The behavior of the folders you create depends on whether you are using POP3 or IMAP4:

- If you are using POP3, folders will behave like they do when using ActiveSync.
- If you are using IMAP4, the folders you create and the messages you move are mirrored on the e-mail server. For example, if you move two messages from the Inbox folder to a folder called Family, the e-mail server will create a copy of the Family folder and move the messages into that folder. Therefore, messages are available to you anytime you connect to your e-mail server, whether it is from your iPAQ H3000, laptop computer, or computer. This synchronization of folders occurs when you create a new folder, move e-mail messages into a folder, or tap **Synchronize Folders** on the **Services** menu. If you want to view the messages in a folder while disconnected from your e-mail server, select the folder then tap **Folder Available Offline** on the **Services** menu. This downloads the e-mail message in the folder to your iPAQ H3000.

# chapter 5

## COMPANION PROGRAMS

The companion programs consist of Microsoft Pocket Word, Microsoft Pocket Excel, Microsoft Money, Windows Media Player for Pocket PC, Microsoft Reader, and Microsoft Pocket Streets.

To switch to a companion program on your iPAQ H3000 Pocket PC, tap **Programs** on the  menu, then tap the program name, or press the QStart button, select a category from the pop-up menu at the bottom of the screen, then tap the program icon.

### Pocket Word

Pocket Word works with Microsoft Word on your computer to give you easy access to copies of your documents. You can create new documents on your iPAQ H3000, or you can copy documents from your computer to your iPAQ H3000. Synchronize documents between your computer and your iPAQ H3000 so that you have the most up-to-date content in both locations.

Use Pocket Word to create documents, such as letters, meeting minutes, and trip reports. To create a new file, tap , **Programs**, **Pocket Word**, then **New**. A blank document appears. Or, if you've selected a template for new documents in the **Options** dialog box, that template appears with appropriate text and formatting already provided. You can open only one document at a time; when you open a second document, you'll be asked to save the first. You can save a document you create or edit in a variety of formats, including Pocket Word (.psw), Rich Text Format (.rtf), and Plain Text (.txt).

Pocket Word contains a list of the files stored on your iPAQ H3000. Tap a file in the list to open it. To delete, make copies of, and send files, tap and hold a file in the list. Then, select the appropriate action on the pop-up menu.

Select the type of folder you want displayed in the list.

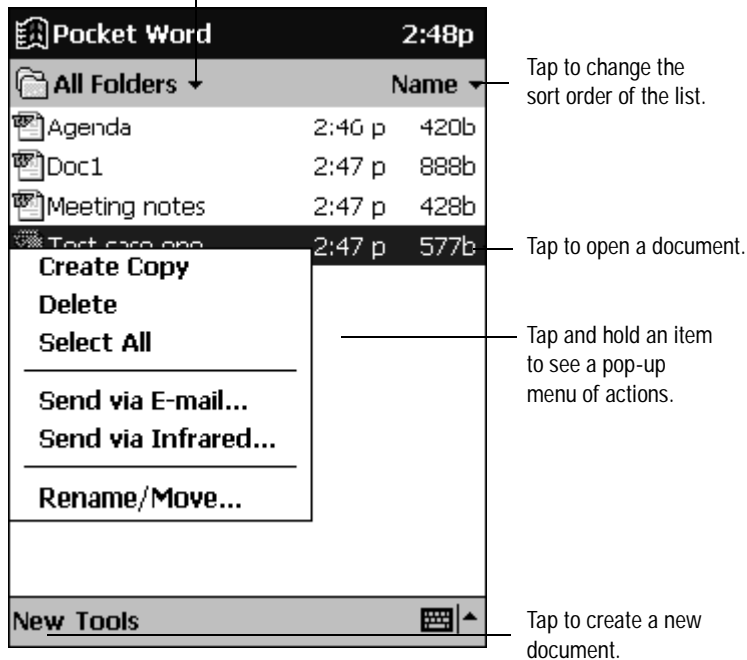

You can enter information in Pocket Word in one of four modes (writing, drawing, typing, and recording), which are displayed on the **View** menu. Each mode has its own toolbar, which you can show and hide by tapping the Show/Hide Toolbar button on the command bar.

**NOTE:** You can change the zoom magnification by tapping **View** then **Zoom**. Then select the percentage you want. Select a higher percentage to enter text and a lower one to see more of your document.

**NOTE:** If you're opening a Word document created on a computer, select **Wrap to Window** on the **View** menu so that you can see the entire document.

## Typing Mode

Using the input panel, enter typed text into the document. For more information on entering typed text, see Chapter 2.

To format existing text and to edit text, first select the text. You can select text as you do in a Word document, using your stylus instead of the mouse to drag through the text you want to select. You can search a document to find the text you want by tapping **Edit** then **Find/Replace**.



Tap to return to the document list (changes are saved automatically).

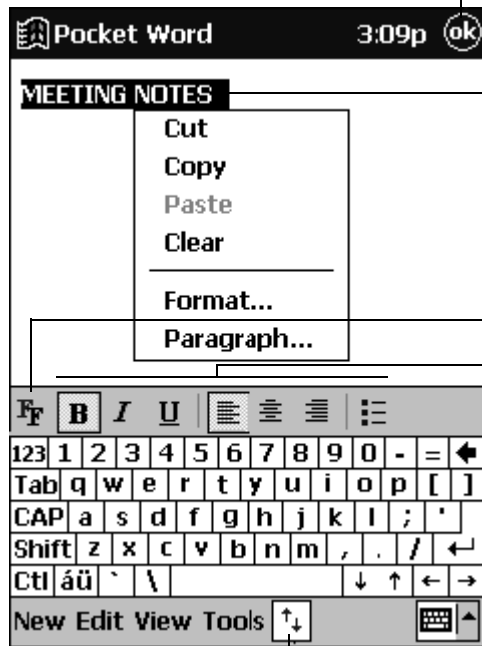

Tap and hold to see a pop-up menu of actions.

Tap to change formatting options.

Tap to format text.

Tap to show or hide the toolbar.

## Writing Mode

In writing mode, use your stylus to write directly on the screen. Ruled lines are displayed as a guide, and the zoom magnification is greater than in typing mode to allow you to write more easily. For more information on writing and selecting writing, see Chapter 2.

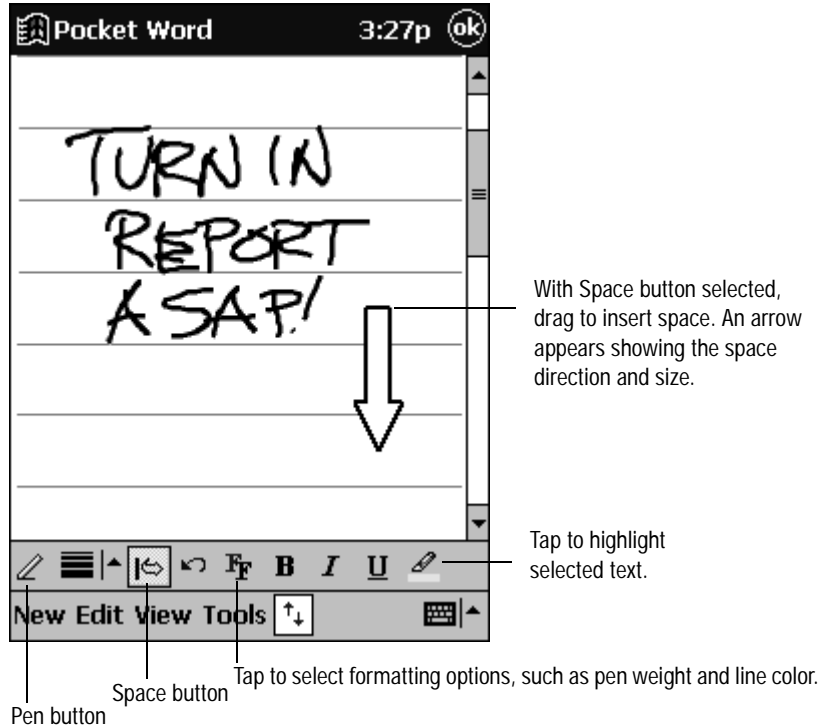

**NOTE:** If you cross three ruled lines in a single stylus stroke, the writing becomes a drawing, and can be edited and manipulated as described in the following section.

Written words are converted to graphics (metafiles) when a Pocket Word document is converted to a Word document on your computer.

## Drawing Mode

In drawing mode, use your stylus to draw on the screen. Gridlines appear as a guide. When you lift your stylus off the screen after the first stroke, you'll see a drawing box indicating the boundaries of the drawing. Every subsequent stroke within or touching the drawing box becomes part of the drawing. For more information on drawing and selecting drawings, see Chapter 2.

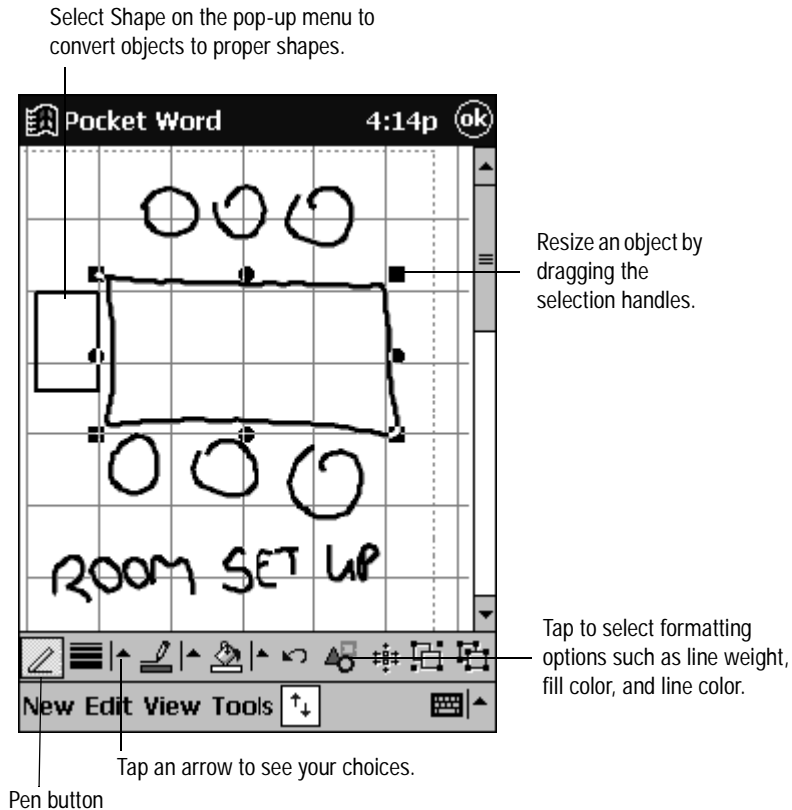

## Recording Mode

In recording mode, embed a recording into your document. Recordings are saved as .wav files. For more information on recording, see “Enter Information on Your iPAQ” in Chapter 2. For more information on using Pocket Word, tap  then **Help**.

## Pocket Excel

Pocket Excel works with Microsoft Excel on your computer to give you easy access to copies of your workbooks. You can create new workbooks on your iPAQ H3000, or you can copy workbooks from your computer to your iPAQ H3000. Synchronize workbooks between your computer and your iPAQ H3000 so that you have the most up-to-date content in both locations.

Use Pocket Excel to create workbooks, such as expense reports and mileage logs. To create a new file, tap , **Programs**, **Pocket Excel**, then **New**. A blank workbook appears. Or, to select a template for a new workbook, tap **Tools**, **Options**, then tap **New**. The template you selected appears with appropriate text and formatting already provided. You can open only one workbook at a time; when you open a second workbook, you’ll be asked to save the first. You can save a workbook you create or edit in a variety of formats, including Pocket Excel (.pxl) and Excel (.xls).

Pocket Excel contains a list of the files stored on your iPAQ H3000. Tap a file in the list to open it. To delete, make copies of, and send files, tap and hold a file in the list. Then select the appropriate action from the pop-up menu.

Pocket Excel provides fundamental spreadsheet tools, such as formulas, functions, sorting, and filtering. To display the toolbar, tap **View** then **Toolbar**.

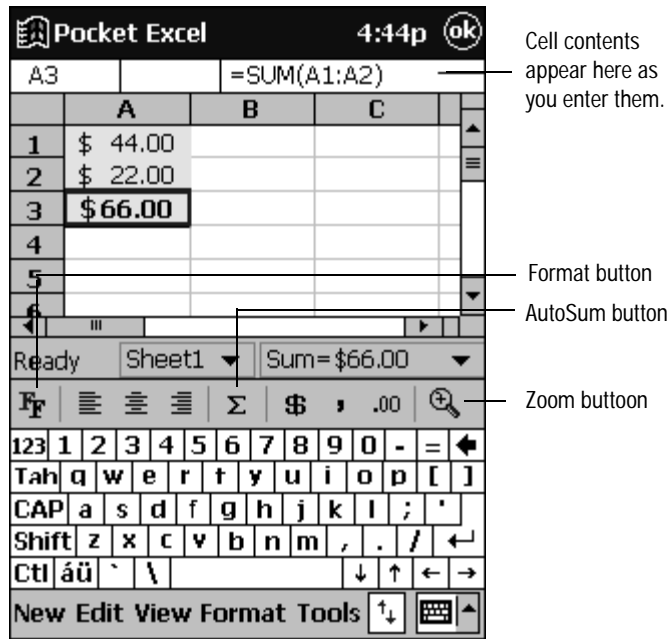

**NOTE:** If your workbook contains sensitive information, you can protect it with a password. To do so, open the workbook, tap **Edit**, then **Password**. Every time you open the workbook, you will need to enter the password, so choose one that is easy for you to remember but hard for others to guess.

## Tips for Working in Pocket Excel

Note the following when working in large worksheets in Pocket Excel:

- View in full-screen mode to see as much of your worksheet as possible. Tap **View** then **Full Screen**. To exit full-screen mode, tap **Restore**.
- Show and hide window elements. Tap **View** then tap the elements you want to show or hide.
- Freeze panes on a worksheet. First select the cell where you want to freeze panes. Tap **View** then **Freeze Panes**. You might want to freeze the top and leftmost panes in a worksheet to keep row and column labels visible as you scroll through a sheet.
- Split panes to view different areas of a large worksheet. Tap **View** then **Split**. Then drag the split bar to where you want it. To remove the split, tap **View** then **Remove Split**.
- Show and hide rows and columns. To hide a hidden row or column, select a cell in the row or column you want to hide. Then tap **Format**, then **Row** or **Column**, then **Hide**.

To show a hidden row or column, tap **Tools**, then **Go To**, then type a reference that is in the hidden row or column. Then tap **Format**, then **Row** or **Column**, then **Unhide**.

For more information on using Pocket Excel, tap  then **Help**.

## Microsoft Money

Use Microsoft Money to easily enter and view your financial transactions, check your account balances, and track your investments. If you are using Microsoft Money on your computer, you should synchronize first so that you won't have to enter your accounts and other required information on your iPAQ H3000 by hand. Before you can synchronize, you will need to run the Setup program found in the MSMoney folder under Extras on the ActiveSync CD. The first time you synchronize, all Microsoft Money information on the iPAQ H3000 will be replaced with information from your computer. If you do not use Microsoft Money on your computer, Microsoft Money on the iPAQ H3000 can still be used to help organize your finances, but you will not be able to synchronize the financial information with your computer.

### Getting Started

*To create a new account:*

1. Tap , **Programs**, **Microsoft Money**, then **New**. A screen for entering account details with a **Required** and an **Optional** tab appears.
2. Enter the name and type of the account on the **Required** tab and the other information you want to record on the **Optional** tab then tap **OK**.

The name of the account appears in the Account Manager with its opening balance.

The total of all balances for your accounts appears at the bottom of the screen.

The upper-left corner of the screen shows which view you are in, for example, Account Manager.

*To navigate within Microsoft Money:*

1. Tap the name **Account Manager**. A list of the five screens within Microsoft Money appears.
2. Tap the screen you want to see.

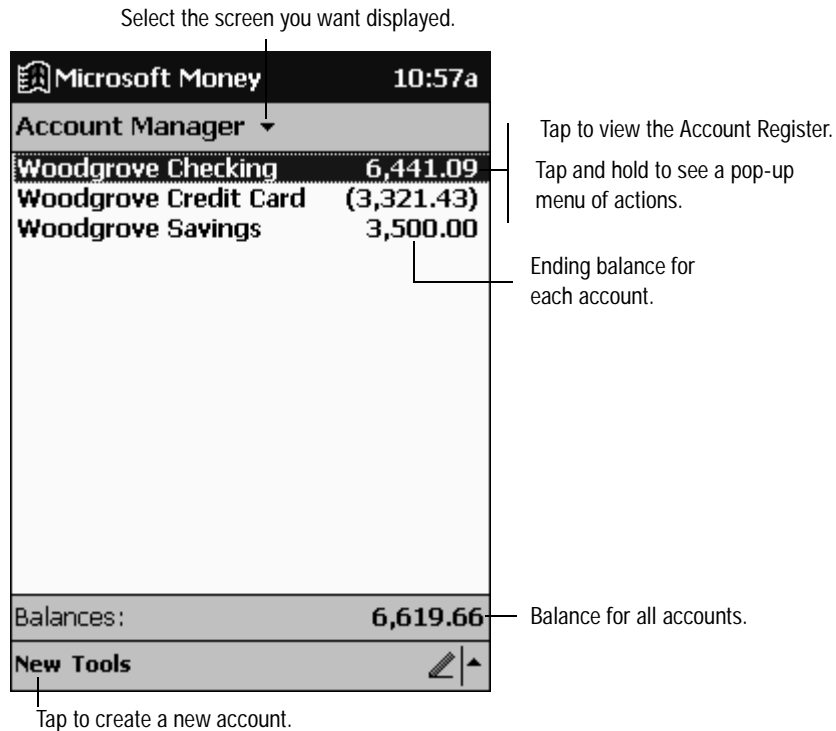

## Using the Account Register

To view the Account Register for an account, tap it in the Account Manager. The Account Register displays all transactions for that account that are stored on your iPAQ H3000. For each transaction, you will see the date, the payee, the amount, and the running balance of your account as a result of the transaction. The ending account balance is displayed at the bottom of the screen.

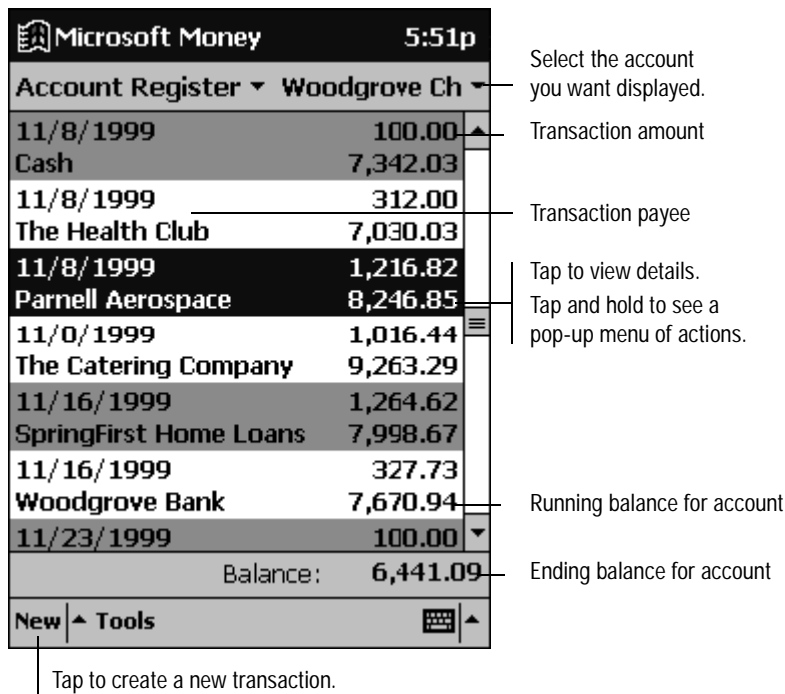

**NOTE:** Tap the name of the current account in the upper-right corner and select another account from the list to switch between accounts.

## Entering Transactions

Once you have the Account Register open, tap **New** to create a new transaction.

On the **Required** tab, Microsoft Money automatically creates a withdrawal and enters today's date. If you are not entering a withdrawal, tap the **Type** box and select **Deposit** or **Transfer**. You can also change the account in which the transaction is being created. Then, tap the **Payee** box. Using the input panel, enter the payee for your transaction. As you type, Microsoft Money tries to guess the payee that you are entering from your list of existing payees. If Microsoft Money guesses correctly, tap another field or tap **Tab** to accept the payee.

When you accept a payee, Microsoft Money enters the same amount, category, and sub-category that you used for the last transaction with that same payee. This information gets entered on the **Required** tab and the **Optional** tab. This AutoComplete+ feature helps you quickly enter similar transactions, such as ATM withdrawals. If AutoComplete+ has entered the wrong information, use the input panel to correct it.

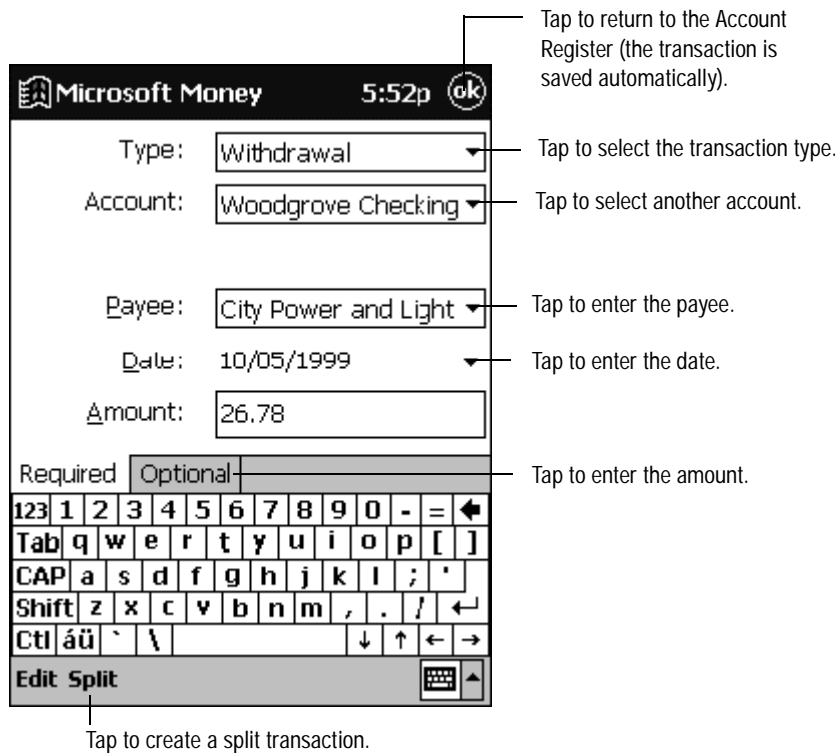

**NOTE:** If you do not want Microsoft Money to automatically enter information, tap **Tools** then **Options** and turn off **AutoComplete+**.

## Entering and Tracking Investments

In the Investments screen, you can track the value of the investments in your portfolio. The Investments screen displays each investment with the current number of shares, their price, and market value. The total market value for all of your investments is displayed at the bottom of the screen.

Tap **New** to create a new investment. On the new investment screen, enter the name, symbol, current price, and number of shares. Tap **OK** to save the new investment.

Microsoft Money can update investment prices from the MoneyCentral website. To do this, open a connection to the Internet and tap **Update Investments** on the **Tools** menu. When the update is complete, Microsoft Money will record the date and time and display it after **Last Quote Update** at the bottom of the screen. If you do not have an Internet connection from your iPAQ H3000, you can manually update the investment prices by tapping the investment and entering a new price with the input panel.



Market symbol for investment

Number of shares

Market symbol for investment	Number of shares	Price	Market Value
AMZN	100	@ \$105.81	\$10,581.00
DIS	55	@ \$28.88	\$1,588.13
EBAY	250	@ \$165.88	\$41,470.00
TOY	95	@ \$20.25	\$1,923.75
WOGSX	150	@ \$44.73	\$6,709.50

Tap to view details.

Tap and hold to see a pop-up menu of actions.

Latest market price

Market value of investment

Total market value of all investments

Time at which quotes were last updated, if available

Tap to update investment prices from MoneyCentral website.

Tap to create a new investment.

**NOTE:** Microsoft Money can get a quote update over any direct (IP) Internet connection, including a wireless connection or network connection. If you cannot get a quote update, check with your Internet service provider (ISP) or network administrator to see if you require a proxy server to connect to the Internet. If so, tap **Tools** then **Options** and set up the proxy server.

For more information on using Microsoft Money, tap  then **Help**.

## Windows Media Player for Pocket PC

Use Windows Media Player for Pocket PC to listen to digital audio files. To switch to Windows Media Player, tap , **Programs**, then **Windows Media Player**.

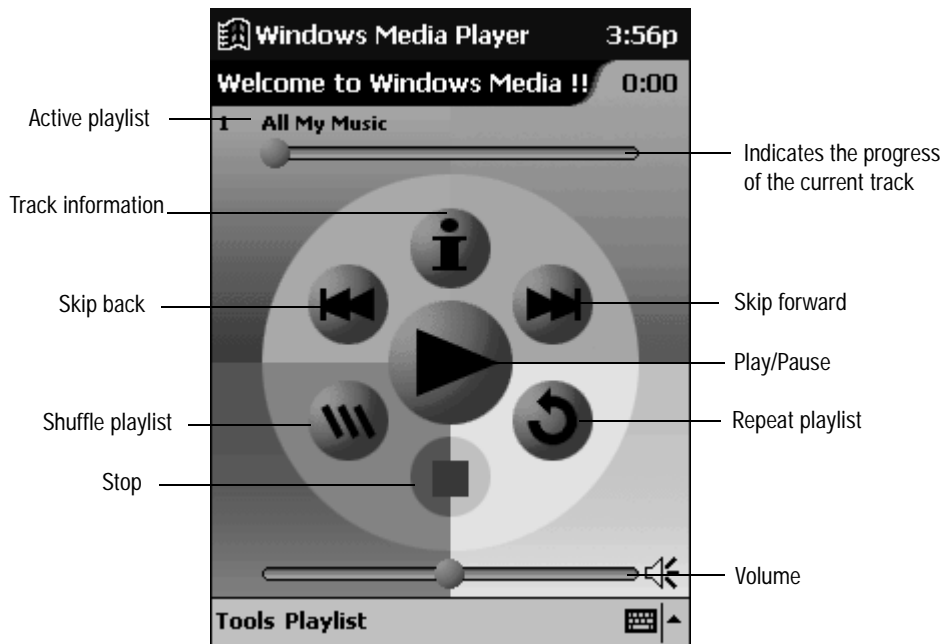

## Using Windows Media Manager for Pocket PC

Use Windows Media Manager for Pocket PC on the computer to create digital audio files in Windows Media format and to transfer audio content to your iPAQ H3000 or storage card. With Windows Media format, you can create high-quality audio for your iPAQ H3000 without using large amounts of iPAQ H3000 memory.

You can transfer the following media formats to your iPAQ H3000 for use with the Windows Media Player: ASF (Advanced Streaming Format), WMA (Windows Media Audio), MP3 (MPEG Audio Layer 3), and WAV (waveform).

Windows Media Manager is included in the Extras folder on the ActiveSync CD. You must install Windows Media Manager on your computer to copy and convert digital audio files.

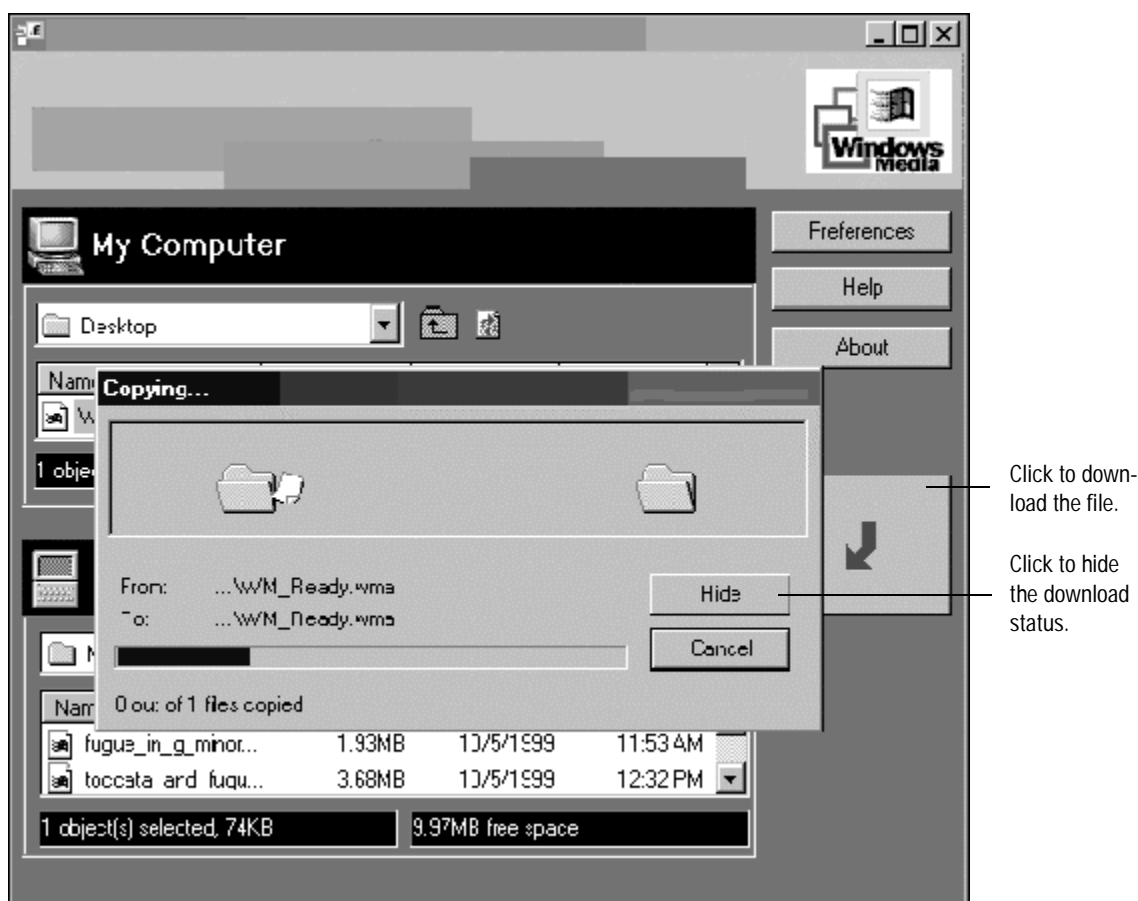

## What is Packaged Content?

Packaged content is digital music that has been encrypted for distribution to prevent unauthorized access to copyrighted content. Windows Media Player for Pocket PC cannot play packaged content without a valid license. First use Windows Media Player on the computer to obtain packaged content that has a license that allows transferring the content to your iPAQ H3000. Then use Windows Media Manager for Pocket PC to transfer the packaged content and its license to your iPAQ H3000 or storage card. To successfully transfer packaged content, your iPAQ H3000 or storage card may require a hardware serial number.

You can play packaged content until the license expires. During license download, you will be informed of the terms of the license. License terms can be for an unlimited time, a set amount of time, or a set number of playbacks. A license can support content being copied to a iPAQ H3000 or storage card an unlimited number of times or one time only. Terms are entirely dependent on the content provider.

## Using the Playlist Manager

Use the playlist manager to set the track playback order. **All My Music** is the default playlist. It contains all digital audio files available for playback on your iPAQ H3000 and storage card. To see a list of recently selected playlists, tap **Select Playlist**. To create or edit playlists, tap **All Playlists**.

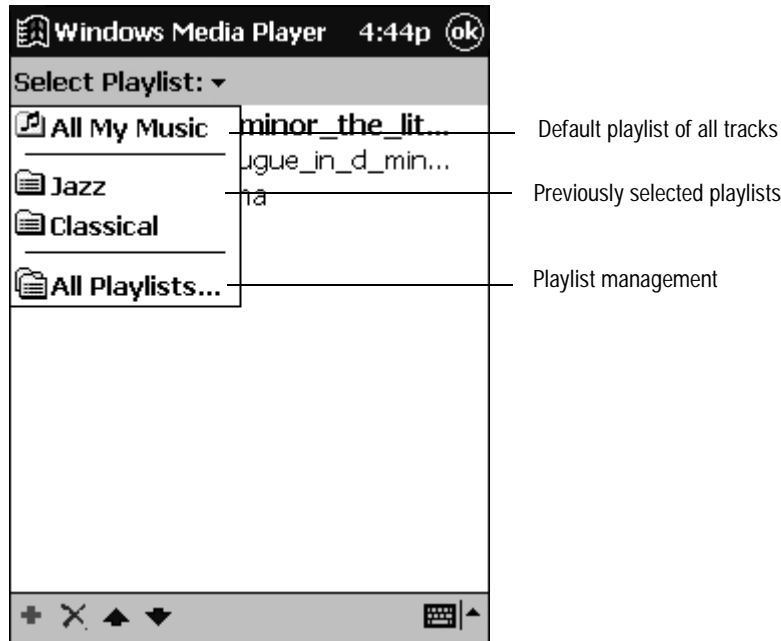

Tap and hold a track or playlist to perform actions such as copying, moving, and deleting. For more information on using Windows Media Player, tap  then **Help**.

## Microsoft Reader

Use Microsoft Reader to read or listen (with Audible) to electronic books on your iPAQ H3000.

Download books to your computer from your favorite eBook website. Then, use ActiveSync to copy the book files to your iPAQ H3000. The books appear in the Reader Library, where you can tap them in the list to open them.

Each book consists of a cover page, an optional table of contents, and the pages of the book. Page through the book by using the Direction key on your iPAQ H3000 or by tapping the page number on each page. You can annotate the book with highlighting, bookmarks, notes, and drawings. You can also search for text and look up definitions for words.

The Reader Guidebook contains all the information you'll need to use the software. To open the Guidebook, tap **Guidebook** on the Reader command bar. Or, on a book page, tap the book title then tap **Guidebook** on the pop-up menu.

To switch to Microsoft Reader, tap , **Programs**, then **Microsoft Reader**.

## Getting Books on Your iPAQ H3000

You can download book files from the Web. Just visit your favorite eBook retailer and follow the instructions to download the book files. Sample books and a dictionary are also included in the MSReader folder in the Extras folder on the ActiveSync CD. Use ActiveSync to download the files from your computer to your iPAQ H3000 as described in the Read Me file in the MSReader folder.

## Using the Library

The Library is your home page. It displays a list of all books stored on your iPAQ H3000 or storage card. You can go to the Library by tapping **Library** on the Reader command bar. Or on a book page, tap the book title then tap **Library** on the pop-up menu.

Tap the title in the Library list to open a book.

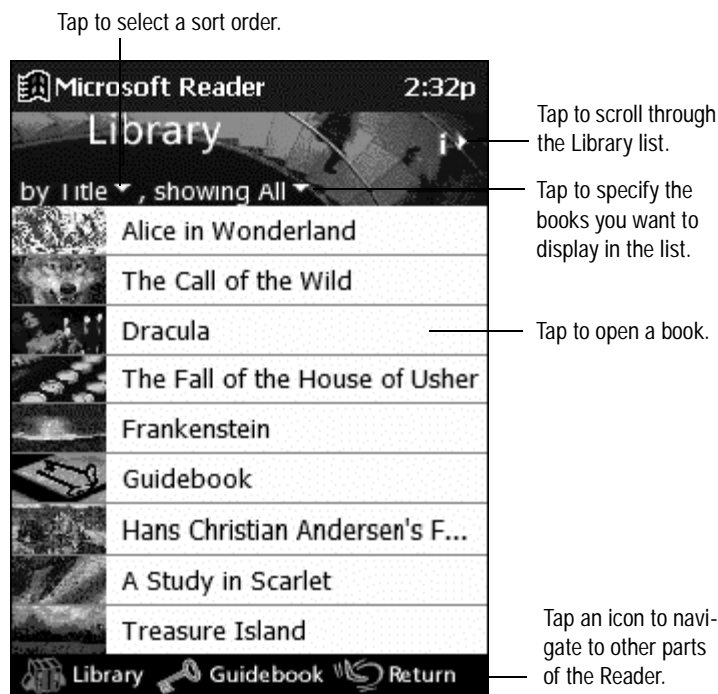

## Reading a Book

Each book consists of a cover page, an optional table of contents, and the pages of the book. Navigation options are listed in the bottom portion of the cover page. The first time you open a book, you'll probably want to go to the first page or to the table of contents, if there is one. Subsequently, whenever you open the book, you'll be automatically taken to the last page read.

In addition to the text, each book page includes a page number and book title.

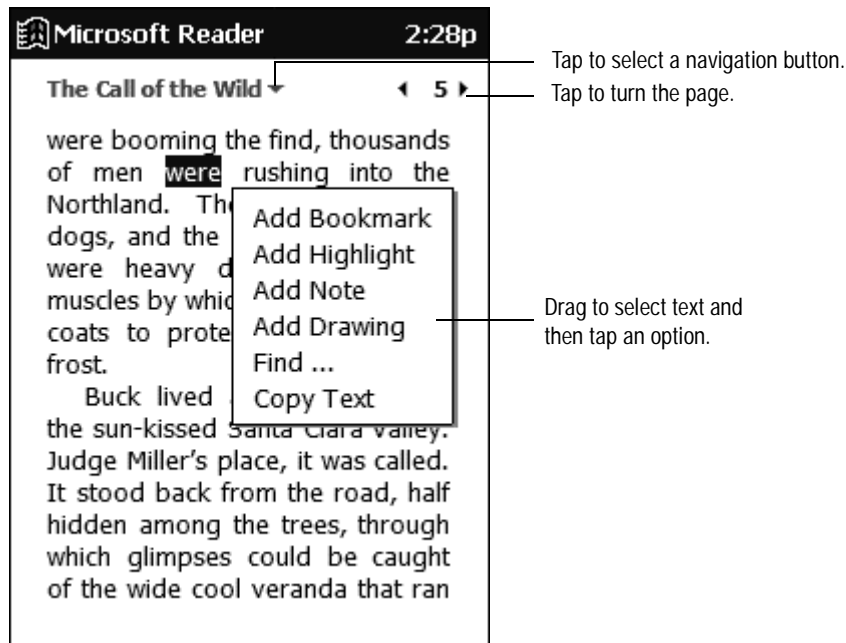

You can also page through a book by using the Navigation button on your iPAQ H3000.

## Using Reader Features

Reading a book electronically gives you several options not available with paper books. These options are available from any book page.

Select text by dragging across the text on the page. Then, tap an option on the pop-up menu, as described here:

- **Search for Text.** Find text in a book by tapping **Find** on the pop-up menu. Change the text that appears in the Find box, if necessary, and tap the desired Find option. The Reader finds the text and highlights it on the page. Tap outside the Find box to close it. To return to your original page, tap the title then tap **Return** on the pop-up menu.
- **Copy Text.** You can copy text from a book into any program that accepts text. On a book page, select the text you want to copy. Then, tap **Copy Text** on the pop-up menu. The text you've copied can be pasted into the program of your choice.
- **Bookmarks.** When you add a bookmark to a book, a color-coded bookmark icon appears in the right margin. You can add multiple bookmarks to a book. Then, from anywhere in the book, you can tap the bookmark icon to go to the bookmarked page.
- **Highlights.** When you highlight text, it appears with a colored background, just as if you used a marker pen.
- **Notes.** When you attach a note to text, you enter the text in a note pad that appears on top of the book page. A note icon appears in the left margin. You can show or hide the note by tapping the icon.

- **Drawings.** When you add a drawing, a drawing icon appears in the bottom-left corner of the page, and drawing tools appear across the bottom of the page. Draw by dragging your stylus.

**NOTE:** To see a list of a book's annotations, including bookmarks, highlights, text notes, and drawings, tap **Annotations Index** on the book's cover page. You can tap an entry in the list to go to the annotated page.

## Removing a Book

When you've finished reading a book, you may want to delete it to conserve space on your iPAQ H3000. If a copy of the book is stored on your computer, you can download it again at any time. To remove a book from your iPAQ H3000, tap and hold the title in the Library list then tap **Delete** on the pop-up menu.

## Pocket Streets

The Pocket Streets feature, included in Microsoft Expedia® Streets and Trips 2000, AutoRoute Express™ Great Britain 2000, and Microsoft MapPoint™ 2000, delivers thousands of miles of street map information to your iPAQ H3000. You can create custom maps of unfamiliar cities, towns, and villages.

## Installing Pocket Streets

Pocket Streets is included in the Extras folder on the ActiveSync CD. To install Pocket Streets on your device, go to the PStreets folder in the Extras folder on the ActiveSync CD and follow the instructions in the Read Me file.

## Getting Maps on Your iPAQ H3000

Sample maps are included in the PStreets folder in the Extras folder on the ActiveSync CD. Use ActiveSync Explore to copy the files from your computer to your iPAQ H3000. For more information on copying files using ActiveSync, see ActiveSync Help.

## Creating Map and Pushpin Files for Your iPAQ H3000

1. Draw a box around the area you want to save as a map in Microsoft Expedia Streets and Trips 2000, AutoRoute Express Great Britain 2000, or Microsoft MapPoint 2000.
2. Click **Create Map For Pocket Streets** on the **Tools** menu.
3. Click **Create**.
4. Navigate to the folder where you want to save the map, then type a file name for the map.

5. Click **Save**. When you create a map, all visible Pushpins in the portion of the map that you selected are also exported. A map file and a corresponding Pushpin file are created for your iPAQ H3000.
6. Copy the maps (.mps) and/or Pushpin files (.psp) that you've created for use with Pocket Streets to the My Documents folder on your iPAQ H3000. For more information on using ActiveSync to copy files, see ActiveSync Help on the computer.

## Viewing Maps

To open a map, tap **Tools, Maps**, then the name of the map you want to see. If you don't see the name, tap **Tools, Maps**, then **Open Map**, select the folder where you stored the map, then tap the name in the list.

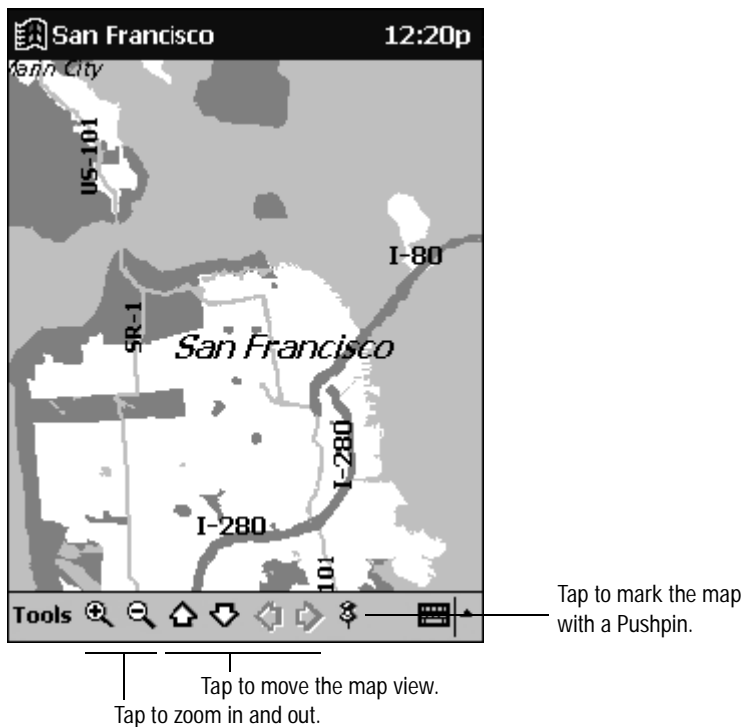

For more information on using Pocket Streets, tap  then **Help**.



# chapter 6

## POCKET INTERNET EXPLORER

Use Pocket Internet Explorer to view Web pages in either of these ways:

- During synchronization with your computer, download your favorite links, mobile favorites, and mobile channels that are stored in the Mobile Favorites subfolder in Internet Explorer on the computer.
- Connect to an Internet service provider (ISP) or network and browse the Web. To do this, you'll need to create the connection first, as described in Chapter 7.

To switch to Pocket Internet Explorer, tap  then **Internet Explorer**.

### The Mobile Favorites Folder

Only items stored in the Mobile Favorites subfolder in the Favorites folder in Internet Explorer on your computer will be synchronized with your iPAQ H3000. This folder was created automatically when you installed ActiveSync.

### Favorite Links

During synchronization, the list of favorite links in the Mobile Favorites folder on your computer is synchronized with Pocket Internet Explorer on your iPAQ H3000. Both computers are updated with changes made to either list each time you synchronize. Unless you mark the favorite link as a mobile favorite, only the link will be downloaded to your iPAQ H3000, and you will need to connect to your ISP or network to view the content. For more information on synchronization, see ActiveSync Help on the computer.

# Mobile Favorites

If you are using Microsoft Internet Explorer 5 on your computer, you can download mobile favorites. (You can install Microsoft Internet Explorer 5 from the Extras folder on the ActiveSync CD.) Synchronizing mobile favorites downloads Web content to your iPAQ H3000 so that you can view Web pages while you are disconnected from your ISP and computer.

Use the Internet Explorer 5 plug-in installed with ActiveSync to create mobile favorites quickly.

*To create a mobile favorite:*

1. Click **Tools** then **Create Mobile Favorite** in Internet Explorer 5 on your computer.
2. Enter a new name in the **Name** box to change the link name.
3. Select a desired update schedule in **Update**.
4. Click **OK**. Internet Explorer downloads the latest version of the Web page to your computer.

**NOTE:** If you want to download the pages that are linked to the mobile favorite you just created, in Internet Explorer on the computer, right-click the mobile favorite then click **Properties**. On the **Download** tab, specify the number of links deep you want to download. To conserve iPAQ H3000 memory, only go one level deep.

5. Synchronize your iPAQ H3000 and computer. Mobile favorites that are stored in the Mobile Favorites folder in Internet Explorer 5 are downloaded to your iPAQ H3000.

**NOTE:** If you did not specify an update schedule in step 3, you will need to manually download content to keep the information updated on your computer and iPAQ H3000. Before synchronizing with your iPAQ H3000, in Internet Explorer on your computer, click **Tools** then **Synchronize**. You will see the most recent content was downloaded to the computer, and you can manually download content, if needed.

You can add a button to the Internet Explorer toolbar for creating mobile favorites. In Internet Explorer 5 on your computer, click **View**, **Toolbars**, then **Customize**.

*To save iPAQ H3000 memory*

Mobile favorites take up storage memory on your iPAQ H3000. To minimize the amount of memory used:

- In the settings for the Favorites information type in ActiveSync options, turn off pictures and sounds or stop some mobile favorites from being downloaded to the iPAQ H3000. For more information, see ActiveSync Help.
- Limit the number of downloaded linked pages. In Internet Explorer on the computer, right-click the mobile favorite you want to change then **Properties**. On the **Download** tab, specify 0 or 1 for the number of linked pages you want to download.

# Channels

Channels are websites designed specifically for offline viewing on your iPAQ H3000. You can subscribe to two types of channels at no fee: AvantGo Channels and mobile channels.

## Using AvantGo Channels

AvantGo is a free interactive service that gives you access to personalized content and thousands of popular websites. Unlike mobile channels, you can subscribe to AvantGo channels directly from your iPAQ H3000. Then, you synchronize your iPAQ H3000 and computer or connect to the Internet to download the content. For more information, visit <http://avantgo.com/help>.

*To sign up for AvantGo:*

1. Add the Mobile Application Link information type to ActiveSync by installing it from the AvantGo folder in the Extras folder on the ActiveSync CD.
2. Tap the **Favorites** button to display your list of favorites in Pocket Internet Explorer on your iPAQ H3000.
3. Tap the AvantGo Channels link.
4. Tap the **Activate** button.
5. Follow the directions on the screen. You will need to synchronize your iPAQ H3000 with your computer then tap the **My Channels** button to complete the AvantGo setup.

When synchronization is complete, tap the AvantGo Channels link in your list of favorites to see a few of the most popular channels. To add or remove channels, tap the **Add** or **Remove** link.

## Using Mobile Channels

Mobile channels are sites you subscribe to on your computer. They are stored in the Channels subfolder in the Mobile Favorites folder in Internet Explorer 4.0 or later and are downloaded to your iPAQ H3000 during synchronization.

To see a list of mobile channels you can subscribe to at no fee, visit the Windows CE Mobile Channel List Web page (<http://www.microsoft.com/windowsce/channels>). Click on the name of the channel you want to subscribe to, then click the **Add Mobile Channel** button and select **Make available offline** to download the channel to your computer. The mobile channel will be transferred to your iPAQ H3000 the next time you synchronize. For more information on synchronization, see ActiveSync Help on the computer.

## Use Pocket Internet Explorer

You can use Pocket Internet Explorer to browse mobile favorites and channels that have been downloaded to your iPAQ H3000 without connecting to the Internet. You can also connect to the Internet through an ISP or a network connection and browse the Web.



To view mobile favorites and channels:

1. Tap the **Favorites** button to display your list of favorites.

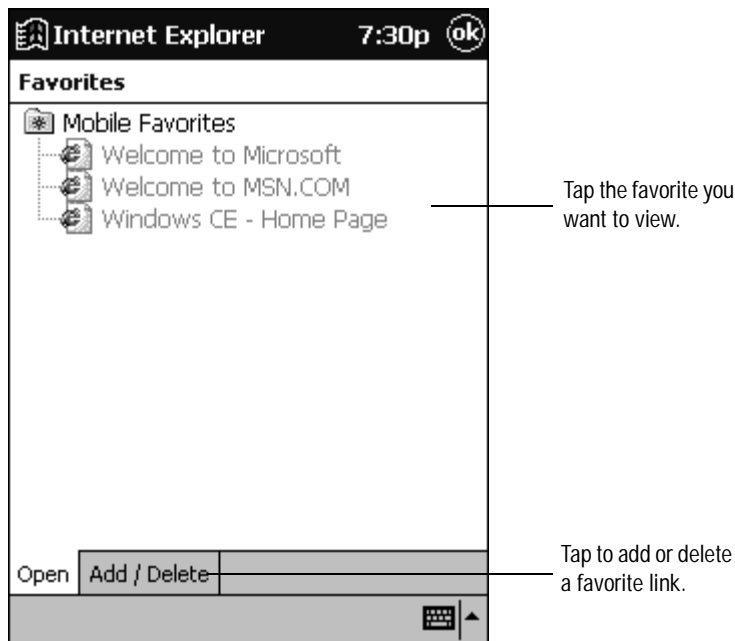

2. Tap the mobile favorite or channel you want to view.

You'll see the page that was downloaded the last time you synchronized with your computer. If the page is not on your iPAQ H3000, the favorite will be dimmed. You will need to synchronize with your computer again to download the page to your iPAQ H3000 or connect to the Internet to view the page.

To browse the Web:

1. Connect to the Internet or your network in either of the following ways:
2. Connect using **Connections**, as described in Chapter 7. Then switch to Pocket Internet Explorer by tapping it on the  menu.
3. Connect in Pocket Internet Explorer. To select a service or type of connection, tap **Tools** then **Options**. Tap the **Connections** tab and select the connection type. Then, whenever you want to connect to the selected service, tap **Tools** then **Connect**.

**NOTE:** You can have Pocket Internet Explorer automatically connect to the Internet when you attempt to access a page that is not stored on your iPAQ H3000 by specifying a connection in the **Connection** tab in **Options** and selecting **Access remote content automatically**.

4. Go to a specific Web page in either of these ways once connected:
  - Tap the **Favorites** button then tap the favorite you want to view.
  - Tap **View** then **Address Bar**. In the address bar that appears at the top of the screen, enter the Web address you want to visit then tap **Go**. Tap the arrow to choose from previously entered addresses.
5. Tap **Tools** then **Disconnect** to end the connection.

**NOTE:** To add a favorite link while using the iPAQ H3000, go to the Web page you want to add, tap the **Favorites** button, tap the **Add/Delete** tab, tap the **Add** button, and enter a name for the favorite link.

# *chapter 7*

## GETTING CONNECTED

You can use your iPAQ H3000 to exchange information with other Windows-powered devices as well as your computer, a network, or the Internet. Use the Infrared (IR) port on your iPAQ H3000 to send and receive files between two devices. In addition to using a cradle, cable, or IR port to connect your iPAQ H3000 to your computer (as described in Chapter 3), you can connect to your computer while away from the office by using a remote connection. You can also connect your iPAQ H3000 to a network or the Internet by using a remote connection. You have the following connection options:

- Connect to your Internet service provider (ISP). Once connected, you can send and receive e-mail messages by using Inbox and view Web pages by using Pocket Internet Explorer. If this is the method you want to use, see “Connect to an ISP.” The communication software for creating an ISP connection is already installed on your iPAQ H3000. Your service provider will provide software needed to install other services, such as paging and fax services.

**NOTE:** Your ISP may not support receiving e-mail on a Pocket PC. Contact your ISP for details.

- Connect to the network at your company or organization. Once connected, you can send and receive e-mail messages by using Inbox, view Web pages by using Pocket Internet Explorer, and synchronize with your computer. If this is the method you want to use, see “Connect to Your Network.”
- Connect to your computer to synchronize remotely. Once connected, you can synchronize information such as your Pocket Outlook data. If this is the method you want to use, see ActiveSync Help on your computer or Connections Help on the iPAQ H3000.

# Transfer Items Using Infrared

Using the IR port on your iPAQ H3000, you can send and receive information, such as contacts and appointments, with another Windows-powered device at speeds of up to 115.2Kbps.

## *To send information:*

1. Switch to the program where you created the item you want to send and locate the item in the list. If you want to send more than one item, drag the stylus across the items you want to send.
2. Align the IR ports so that they are unobstructed and within a range of one foot (30 cm).



3. Tap and hold the item, then tap **Send via Infrared** on the pop-up menu.

**NOTE:** You can also send items, but not folders, from File Explorer. Tap and hold the item you want to send, then tap **Send via Infrared** on the pop-up menu.

## *To receive information:*

1. Align the IR ports so that they are unobstructed and within a range of 12 inches (30 cm).
2. Tap , **Programs**, then **Infrared Receive**.

**NOTE:** You can also receive items from Tasks, Contacts, Calendar, and Notes by tapping **Tools**, then **Receive via Infrared** in list view.



# Connect to an ISP

You can connect to your ISP by creating a modem connection. Once connected, you can send and receive e-mail messages and view Web pages.

*To create a modem connection to an ISP:*

1. Get the following information from your ISP: ISP dial-up access telephone number, user name, password, and TCP/IP settings. Some ISPs require information in front of the user name, such as *MSN/username*.
2. Install a CompactFlash modem card using the optional iPAQ CF Card Expansion Pack or a PCMCIA modem card using the optional iPAQ PC Card Expansion Pack.

**NOTE:** For information on ordering Compaq iPAQ Expansion Packs, see the *Accessories Information* flier included in the shipping box, or visit the Compaq iPAQ H3000 home page at [www.compaq.com/products/handhelds/](http://www.compaq.com/products/handhelds/).

3. Tap  then **Settings**. On the **Connections** tab, tap **Modem**.
4. Tap **New connection**.



5. Enter a name for the connection, such as “ISP Connection.”

6. Select your modem type in the **Select a modem** list. If your modem type does not appear, try re-inserting the modem card.

**NOTE:** You should not need to change any settings in **Advanced**. Most ISPs now use a server-assigned address. If the ISP you are connecting to does not use a server-assigned address, tap **Advanced** then the **TCP/IP** tab and enter the address. When finished, tap **OK** then **Next**.

7. Enter the access phone number, and tap **Next**.
8. Select other desired options, and tap **Finish**.
9. Specify your current location and phone type (most phone lines are tone) on the **Dialing** tab. These settings will apply to all connections you create.

Once you have created the connection, it appears in , **Programs, Connections**. To start the connection, remove your iPAQ H3000 from the cradle, tap the connection icon, enter your user name and password, and tap **Connect**. Once connected, you can:

- Send and receive e-mail messages by using Inbox. Before you can use Inbox, you need to provide the information it needs to communicate with the e-mail server. For specific instructions, see “Connect Directly to an E-mail Server,” later in this chapter.
- Visit Web pages by using Pocket Internet Explorer. For information, see Chapter 6.

**NOTE:** You can quickly return to **Modem Settings** to change connection settings by tapping the **Modem** link at the bottom of the **Connections** folder. To return to the **Connections** folder, tap the **Connections** link.

## Connect to Your Network

If you have access to a network, you can send e-mail messages, view intranet pages, synchronize your iPAQ H3000, and possibly access the Internet. You can connect to your network in one of two ways:

- **Create a modem connection by using a RAS account.** Before you can create this modem connection, your network administrator will need to set up a RAS account for you. If this is the method you want to use, see “To create a modem connection to a network.”
- **Use an Ethernet card and a net tap to connect to the network.** If this is the method you want to use, see “To create an Ethernet connection to a network.”

*To create a modem connection to a network:*

1. Get the following information from your network administrator: dial-up access telephone number, user name, password, domain name, and TCP/IP settings.
2. Install a CompactFlash modem card using the optional iPAQ CF Card Expansion Pack or a PCMCIA modem card using the optional iPAQ PC Card Expansion Pack.

**NOTE:** For information on ordering Compaq iPAQ Expansion Packs, see the *Accessories Information* flier included in the shipping box, or visit the Compaq iPAQ H3000 home page at [www.compaq.com/products/handhelds/](http://www.compaq.com/products/handhelds/).

3. Tap  then **Settings**. On the **Connections** tab, tap **Modem**.
4. Tap **New connection**.
5. Enter a name for the connection, such as “Company Connection.”
6. Select your modem type in the **Select a modem** list. If your modem type does not appear, try reinserting the modem card.

**NOTE:** You should not need to change any settings in **Advanced**. Most servers now use a server-assigned address. If the server you are connecting to does not use a server-assigned address, tap **Advanced** then the **TCP/IP** tab and enter the address. When finished, tap **OK** then **Next**.

7. Enter the access phone number, and tap **Next**.
8. Select other desired options, and tap **Finish**.
9. Specify your current location and phone type (most phone lines are tone) on the **Dialing** tab. These settings will apply to all connections you create.

Once you have created the connection, it appears in , **Programs, Connections**. To start the connection, remove your iPAQ H3000 from the cradle, tap the connection icon, enter your user name, domain, and password, and tap **Connect**. Once connected, you can:

- **Send and receive e-mail messages by using Inbox.** Before you can use Inbox, you need to provide the information it needs to communicate with the e-mail server. For specific instructions, see “Connect Directly to an E-mail Server,” later in this chapter.
- **Visit Internet or intranet Web pages by using Pocket Internet Explorer.** You may need to set up a proxy server to visit Internet Web pages. For more information on setting up a proxy server, see Pocket Internet Explorer Help on the iPAQ H3000.
- **Synchronize.** For more information, see ActiveSync Help on the computer.

### *To create an Ethernet connection to a network:*

You do not need to create a new connection on your iPAQ H3000. Instead, you must purchase and configure an Ethernet card that is compatible with your iPAQ H3000.

1. Get the following information from your network administrator: user name, password, and domain name.
2. Install the optional CompactFlash or PCMCIA Ethernet card into your optional CF Card or PC Card Expansion Pack. For instructions on inserting and using the Ethernet card, see the owner's manual for the card.

**NOTE:** For information on ordering Compaq iPAQ Expansion Packs, see the *Accessories Information* flier included in the shipping box, or visit the Compaq iPAQ H3000 home page at [www.compaq.com/products/handhelds/](http://www.compaq.com/products/handhelds/).

**Network Settings** will appear automatically the first time you insert the card, so that you can configure the Ethernet card. Most networks use DHCP, so you should not have to change these settings unless your network administrator instructs you to do so.



3. Tap **OK**. (If it does not appear or to change settings later, tap  then **Settings**. On the **Connections** tab, tap **Network** then the adapter you want to change.)
4. Connect the Ethernet card to the network by using a network cable. For information, see your owner's manual.

*If you want to synchronize your iPAQ H3000, tap , then **Programs**. Tap the **Connections** folder, then **ActiveSync**. Select **Network Connection** as the connection method then tap **Connect**. Remote synchronization with a computer will work only if you have set up a partnership with that computer through ActiveSync and have set ActiveSync to allow remote connections. Other restrictions apply. For more information on synchronizing remotely, see ActiveSync Help on the computer.*

*If you want to access your e-mail server or the intranet, tap  then **Settings**. On the **Connections** tab, tap **Network** then the **Identification** tab. Enter your user information. If you need assistance, see your network administrator.*

Once connected, you can do the same activities as listed in the preceding section.

# End a Connection

If you started the connection from a program, such as Inbox or Pocket Internet Explorer, disconnect from that program first. Then, tap  then **Today**. Tap  or  at the bottom of the screen then **Disconnect**. To end a network connection, remove the card from your iPAQ H3000.

# Connect Directly to an E-mail Server

You can set up a connection to an e-mail server so that you can send and receive e-mail messages by using a modem or network connection and Inbox on your iPAQ H3000.

**NOTE:** The ISP or network must use a POP3 or IMAP4 e-mail server and an SMTP gateway.

Inbox does not currently support connecting with proprietary e-mail protocols such as Juno, or Virgin Net. However, you can still access the Internet through these services. There may be third-party programs available that would enable you to send and receive e-mail messages through proprietary protocols.

You can use multiple e-mail services to receive your messages. For each e-mail service you intend to use, first set up and name the e-mail service. If you use the same service to connect to different mailboxes, set up and name each mailbox connection.

*To set up a e-mail service:*

1. Tap **Services**, then **New Service** in Inbox on your iPAQ H3000.

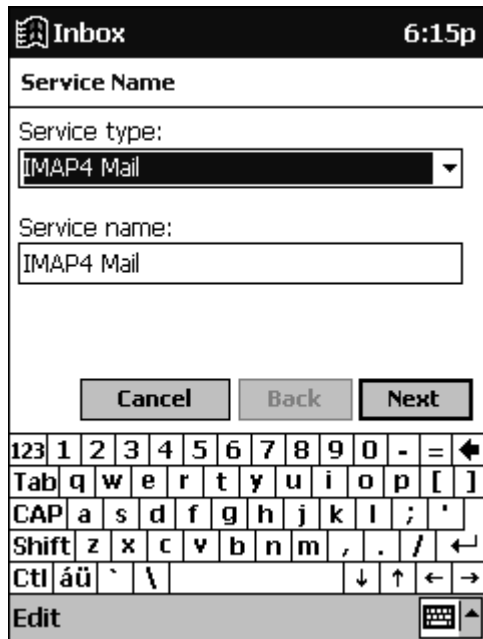

2. Select POP3 or IMAP4 as the service type, name the service, and tap **Next**. For information on which service type to select, ask your ISP or network administrator.
3. Select a connection from the **Connection** list. If you have not created a connection, select **Create new connection** and follow the steps in the wizard. When you return to this screen at the end of the wizard, select the connection you created from the **Connection** list.

A wizard will walk you through the remaining steps. For an explanation of a screen, tap **Start** then **Help**. When finished, tap **Services** then **Connect** to connect to your e-mail server. For more information on using the Inbox program, see “Inbox: Sending and Receiving E-mail Messages” in Chapter 4.

## Get Help on Connecting

More information on the procedures described here, as well as information on additional procedures, can be found in the following locations:

- “Inbox: Sending and Receiving E-mail Messages” in Chapter 4.
- Online Help on the iPAQ H3000. Tap  then **Help**. Tap **View, All Installed Help**, then **Inbox** or **Connections**.
- ActiveSync Help on the computer. In ActiveSync, click **Microsoft ActiveSync Help** on the **Help** menu.
- Appendix A, “Tips and Troubleshooting”.

# *appendix a*

## TIPS AND TROUBLESHOOTING

This chapter contains troubleshooting information that can help you to solve any problems you might encounter with your iPAQ H3000. It also has a tips section that may help you to get better service from your iPAQ H3000.

If you can't solve a particular problem, see "Finding Information" in Chapter 1. The various documents and websites listed here may have the information you need to solve the problem.

To help diagnose a malfunction, use the Diagnostic utility, which activates a debugging and system diagnostic tool. Press the QMenu button, then tap **QUtilities, Self Test**. For more information, see "Self Test" in Chapter 2.

If you encounter a problem that you cannot solve, contact Compaq technical support or your service provider for assistance.

## Reset the iPAQ H3000 and Clear Memory

### Resetting the iPAQ

If your iPAQ H3000 responds slowly, stops responding as expected, or "freezes," try resetting it. A reset causes the iPAQ H3000 to restart and re-adjust memory allocation. Unsaved data in open windows may be lost. Use the stylus to press and hold the Reset button for about two seconds.

**NOTE:** Do not turn off your iPAQ as the it must remain on in order to reset.



## Clearing memory

If you want to clear all data from your iPAQ H3000 and return it to the factory settings, you should clear the memory.



Clearing memory deletes all data and restores the iPAQ H3000 to its default settings. Programs installed at the factory remain, while data you have created and programs you have installed are erased.

1. Using the stylus, slide open the On/Off door on the base of the iPAQ H3000.

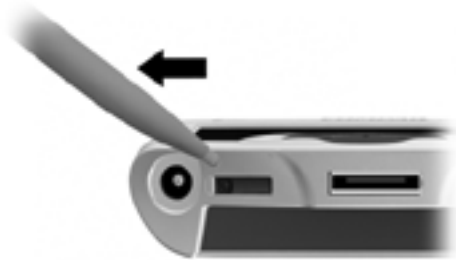

2. Slide the On /Off switch to the Off position using the stylus. Wait about one minute, then slide the switch to the On position.

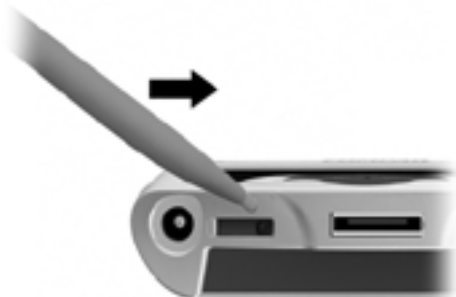



3. Close the Battery On/Off door using the stylus.

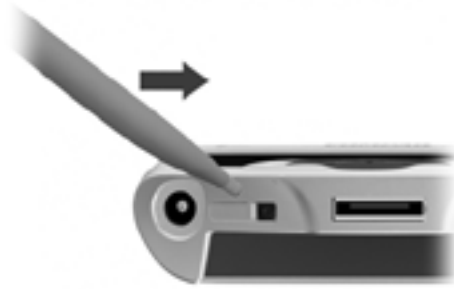

**NOTE:** Use CF Backup/Restore or ActiveSync to keep a backup of your iPAQ data so that if you need to clear memory, you can restore the data on your iPAQ. For more information, see “Backup and Restore Data” in Chapter 2, and ActiveSync Help on the computer.

## Battery Loses Power

When the battery is low, you will see a battery icon in the status bar of the **Today** screen. Recharge a low battery as soon as possible. If your iPAQ H3000 shuts down, you still have about 24 hours to recharge the battery before you lose the data on your Pocket PC.



Letting the battery fully discharge has the same effect as clearing memory: all data is lost and your iPAQ H3000 returns to its factory settings. If your iPAQ H3000 shuts down, you should recharge the battery within 24 hours.

You want your iPAQ H3000 battery charge to last as long as possible, especially when you’re on the road. Under normal conditions, you can get many hours of use from a full charge. The following tips to help you get the most from them:

### *Use external power whenever possible*

Use the AC adapter to plug your iPAQ H3000 into external power whenever possible, especially when:

- Establishing a remote connection (some modems use a lot of power).
- Using the backlight feature of your iPAQ H3000 display.
- Connecting to a computer.
- Playing audio files for extended periods.

### *Shorten auto-suspend time*

While on battery power, your iPAQ H3000 automatically suspends operation if you haven’t touched the hardware buttons or used the stylus for two minutes. Maximize battery life by shortening the time. Press the QMenu button, then press **Power**, and adjust the **On battery power** setting.

### *Turn off sounds you don't need*

The iPAQ H3000 produces sounds in response to a number of events, such as warnings, appointments, and screen taps or hardware-button presses. To optimize battery life, turn off any sounds you don't need. Tap  then **Settings**. On the **Personal** tab, tap **Sounds & Reminders** and clear check boxes on the **Volume** and **Reminders** tabs.

### *Turn off notification light*

Tap  then **Settings**. On the **Personal** tab, tap **Sounds & Reminders**. On the **Reminders** tab, clear the **Flash light for** check box.

## If You Forget Your Password

If you forget your password, you'll need to clear memory on the iPAQ H3000. See "Reset the iPAQ H3000 and Clear Memory," earlier in this appendix.

If you've used **ActiveSync** or **CF Backup/Restore** to create a backup file, all of your program data can be restored. Your Windows CE password is removed and you can set a new password.





## If You Run Out of iPAQ H3000 Memory

Memory on your iPAQ H3000 is shared between storage memory and program memory. Storage memory is used to store the information you create and programs you install. Program memory is used to run programs on your iPAQ H3000. The iPAQ H3000 automatically manages the allocation between storage and program memory. However, in some situations, such as when memory is low, the iPAQ H3000 may not be able to automatically adjust the allocation. If you receive a message stating that storage or program memory is unavailable, try the following solutions:

## Storage memory



Do not delete files of which the function is unknown. This can cause programs or features to malfunction. It may be appropriate to make a backup before deleting files.

- Move data to a storage card.
- Tap , **Programs**, then **File Explorer**. Tap and hold the file you want to move, and tap **Cut**. Browse to the My Documents folder in the storage card folder, tap **Edit**, then tap **Paste**. Files stored in folders other than My Documents or stored in subfolders within subfolders in My Documents may not show up in the list view of some programs. When using Notes, Pocket Word, or Pocket Excel, you can also move files by opening the item and tapping **Tools** or **Edit** then **Rename/Move**.
- Move e-mail attachments. In Inbox, tap **Tools** then **Options**. On the **Storage** tab, select **Store attachments on storage card**. All attachments are moved to the storage card, and new attachments are automatically stored on the storage card.
- Set programs such as Notes, Pocket Word, and Pocket Excel to automatically save new items on the storage card. In the program, tap **Tools** then **Options**.
- If you are copying files from your computer or device to your iPAQ H3000, try adjusting the slider in the **Memory** setting. Tap  then **Settings**. On the **System** tab, tap **Memory** and check whether the slider can be adjusted manually before copying files.
- Delete unnecessary files. Tap , **Programs**, then **File Explorer**. Tap and hold the file, then tap **Delete** on the pop-up menu. To find your largest files, tap  then **Find**. In the **Type** list, tap **Larger than 64 KB**, then tap **Go**.
- In Internet Explorer options, delete all files and clear history. In Internet Explorer, tap **Tools** then **Options**. Tap **Delete Files** and **Clear History**.
- Remove programs you no longer use. Tap  then **Settings**. On the **System** tab, tap **Remove Programs**. Tap the program you want to remove, then **Remove**.
- Clear program memory as described in the following section. This will free some program memory so that it can be allocated to storage memory.

## Program memory

- Stop programs you are not currently using. In most cases, programs automatically stop to free needed memory. However, in some situations, such as when confirmation dialog boxes are waiting for a user response, the program may not be able to automatically stop. To check the state of your active programs, tap  then **Settings**. On the **System** tab, tap **Memory** then the **Running Programs** tab. Tap the program you want to view, then tap **Activate**. Close any open windows or messages and return the program to list view. If this doesn't work, you can stop the program manually. First, make sure that your work is saved by closing open items and returning the program to list view. Then, stop the program by tapping **Stop** or **Stop All** on the **Running Programs** tab.
- Clear storage memory as described in the preceding section. This will free some storage memory so that it can be allocated to program memory.
- Reset your iPAQ H3000, as described in “Reset the iPAQ H3000 and Clear Memory,” earlier in this appendix.

## Screen Freezes or Responds Slowly

Reset your iPAQ H3000. See “Reset the iPAQ H3000 and Clear Memory,” earlier in this appendix. If the symptom continues, you may have run out of memory. Check your memory usage and clear storage memory as described above.

## Screen is Blank

If the iPAQ H3000 doesn't respond when you briefly press the Power button, press and hold the button for a full second. If that doesn't work, try the following in order until the problem is resolved:

- Plug the iPAQ H3000 into AC power.
- Reset the iPAQ H3000. See “Reset the iPAQ H3000 and Clear Memory,” earlier in this appendix.

## Screen is Dark

Prolonged exposure to direct sunlight may cause your iPAQ H3000 screen to temporarily darken. This is normal for LCD screens and is not permanent.

## Screen is Hard to Read

- Turn on the backlight, by holding down the Power button for one second.
- Adjust the backlight brightness level. Press the QMenu button, then tap **Backlight, Super Bright**.
- Position a lamp so that the light shines directly on the screen.
- If you're having a hard time viewing a document in Notes, try changing the size of the view. To do this, tap a zoom percentage on the **Tools** menu. In Pocket Word and Pocket Excel, on the **View** menu, tap **Zoom** then select a zoom percentage. In Pocket Internet Explorer, on the **View** menu, tap **Text Size** then select a size.
- If you're having a hard time viewing Pocket Outlook data, try enlarging the display font. To do this within Calendar, Tasks, or Contacts, tap **Tools**, then **Options**, then select **Use large font**.

## Inaccurate Response to Stylus Taps

Adjust the touch screen to respond more accurately to screen taps. Tap  then **Settings**. On the **System** tab, tap **Align Screen**.

## Slow or No Response

Reset the iPAQ H3000. See “Reset the iPAQ H3000 and Clear Memory,” earlier in this appendix.

## Infrared (IR) Connection Problems

If you are unable to use IR to transfer information, try the following:

- Transfer only one file or no more than 25 contact cards at a time.
- Line up the IR ports so that they are unobstructed and within a range of 12 inches (30 centimeters).
- Make sure nothing is between the two IR ports.
- Adjust the room lighting. Some types of light interfere with IR connections. Try moving to a different location or turning off some lights.

# Modem Connection Problems



You may encounter the following problems when using a modem. Additional troubleshooting information is available in Connections Help on the iPAQ H3000 and Active-Sync Help on the computer.

## *Can't dial out*



- Remove your iPAQ H3000 from the cradle. You cannot connect using a modem if your iPAQ H3000 has an active connection with the computer.
- Verify that the iPAQ Expansion Pack is installed properly and that the modem is firmly seated and connected to the telephone jack.
- Make sure the telephone line is analog. (Analog telephone lines transmit data in analog instead of digital form. Your home telephone line is most likely analog, while office telephone lines are often digital.)



Connecting a modem to a digital telephone line may damage your modem. If unsure, ask a knowledgeable person before connecting the modem.

- If you create a modem connection for an external modem, select **Hayes Compatible on COM1** as your modem. If you are using a modem card, select the modem card as your modem.
- To use an external modem, you need to use a NULL modem cable and appropriate adapters to connect the external modem to your iPAQ H3000.
- Make sure the modem is waiting for a dial tone. Tap  then **Settings**. On the **Connections** tab, tap **Modem**. Tap your connection and tap **Next** twice. Make sure **Wait for dial tone before dialing** is selected.
- For international calls, allow more time for the call to go through. Tap  then **Settings**. On the **Connections** tab, tap **Modem**. Tap your connection and tap **Next** twice. Clear **Cancel the call if not connected within** or increase the number of seconds allowed. For information on dialing patterns, see Connections Help on the iPAQ H3000.



### *Can dial out but can't make a proper connection*

- Make sure the network to which you are trying to connect supports the Point-to-Point Protocol (PPP). Your Internet service provider or network administrator can verify this.
- Verify that the location is correct. Tap  then **Settings**. On the **Connections** tab, tap **Modem**. On the **Dialing** tab, make sure that **Location** reflects your current location. Tap **Dialing Patterns** to make sure the correct sequence of numbers is being dialed. For information on dialing patterns, see Connections Help on the iPAQ H3000.
- Verify that you are using the right phone number for the modem you are trying to reach. Tap  then **Settings**. On the **Connections** tab, tap **Modem**. Tap the connection then **Next** and double-check the phone number you are trying to reach.

### *Connection is unreliable*



- Make sure the modem is firmly seated and connected to your iPAQ H3000 and the telephone jack.
- Disable call waiting. Tap  then **Settings**. On the **Connections** tab, tap **Modem**. On the **Dialing** tab, select **Disable call waiting**. Then enter the disable code specified by your telephone company.

# Network Connection Problems

- The following solutions may help if you encounter problems when using a network card for network connections. Additional troubleshooting information is available in Connections Help on the iPAQ H3000 and ActiveSync Help on the computer.
- Verify that you have an Ethernet card that is compatible with your iPAQ H3000.
- Verify that you have added necessary server information. Tap  then **Settings**. On the **Connections** tab, tap **Network**. Tap your installed adapter (usually your Ethernet card's name) and enter any necessary information. Most networks use DHCP, so you should not have to change these settings unless your network administrator instructs you to do so.
- If **Network Connection** isn't listed as a connection method in the **ActiveSync** dialog box when starting synchronization, wait a few minutes and try again. Also, if synchronization does not start right away, the network is probably busy, and it may take a minute for your iPAQ H3000 to connect to the network.
- Make sure that the proper drivers for your card are installed on the iPAQ H3000. For more information, see the owner's manual for the network card.
- Verify with your network administrator that your user name and password are correct.
- Verify with your network administrator that the network you are trying to connect to is available, or try to connect to it from another computer.
- You may need to change the device name if you are trying to connect to a network and cannot because another device with the same name is already connected. To change the device name, tap  then **Settings**. On the **System** tab, tap **About**, then the **Device ID** tab.

# USB Cable Connection Problems

The following solutions may help if you encounter problems when connecting to your computer. Additional troubleshooting information is available in Connections Help on the iPAQ H3000 and ActiveSync Help on the computer.

- Ensure the iPAQ H3000 is turned on.
- If a modem or Ethernet card is inserted into your iPAQ H3000, remove it.
- Ensure that you do not have any other active connections. Tap  then **Today**. Tap  or  at the bottom of the screen, then **Disconnect**.
- Ensure the USB cradle's cable is securely plugged into the USB port on the back of your computer. Use the cable that came with the iPAQ H3000 cradle without any extra cables or extenders attached.
- Ensure your iPAQ H3000 is securely placed into the cradle.



# Routine Maintenance

This section provides recommended guidelines for taking care of your iPAQ H3000. Following these guidelines helps ensure the longevity of your iPAQ and reduces the risk of damage.

## Routine Care

To keep your iPAQ H3000 in good condition and working properly, follow these guidelines:

- Keep your iPAQ away from excessive moisture and temperature extremes. Do not expose your iPAQ to liquids or precipitation.
- Do not place anything on top of your iPAQ to prevent damage to the screen.
- Store your iPAQ in a protective case when not in use.
- Clean your iPAQ by wiping the screen and the exterior with a soft, damp cloth moistened only with water.



To reduce the risk of electrical shock or damage to the internal components, do not spray liquid directly on the screen or allow excess liquid to drip inside your iPAQ. Using soap or other cleaning products on the screen may discolor the finish and damage the screen.

- Avoid exposing your iPAQ to direct sunlight or strong ultraviolet light for extended periods of time. Also avoid scratching the surface of the screen and banging it against hard objects.
- Only use the iPAQ stylus to prevent scratching the screen.

## Battery Guidelines

Because of the type of battery used in your iPAQ H3000, follow local regulations regarding the safe disposal of your iPAQ H3000. Your Compaq vendor can advise you on local regulations, and/or the existence of any battery disposal programs in operation.



In North America, dispose of the iPAQ H3000 by taking advantage of the Compaq battery recycling program. You will be provided with a postage-paid battery pack mailer preaddressed to a reclamation facility where the metals are recycled.

The iPAQ H3000 should not be disposed of along with the general household waste. In order to forward them to recycling or dispose of them properly, please use the public collection system or return them to Compaq, your authorized Compaq partners, or their agents.

# Travel Guidelines

For safety and convenience when traveling with your iPAQ H3000, follow these guidelines:

- Back up your data before you leave.
- Take a backup copy of your data with you.
- Disconnect all external equipment from your iPAQ.
- Take the AC adapter and new batteries with you.
- Hand-carry your iPAQ in a protective case. Do not check it with your luggage.
- Be aware of potential effects of airport security devices on your iPAQ H3000.



There are three types of airport security devices: X-ray machines, magnetic detectors (the device you walk through), and security magnetic wands. You can send your device through airport X-ray machines. However, Compaq recommends that you do not send your iPAQ through magnetic detectors or expose it to security magnetic wands.

- Check with the airline if you plan to use your iPAQ on the plane. In-flight use of electronic devices is at the discretion of the airline.

## International Travel

Before traveling internationally with your iPAQ H3000, be sure to:

- Check local customs regulations.
- If using an external modem or CompactFlash/PCMCIA card modem, be sure to have the correct modem and cable for the country you are visiting. Telephone lines differ from country to country.

## Shipping Guidelines

When shipping your iPAQ H3000, follow these guidelines:

- Safeguard your data by making a backup copy.
- If shipping the backup copy, be sure that the medium (diskette, tape, or CompactFlash card) is not exposed to electrical or magnetic impulses while stored or in transit.
- Turn off your iPAQ and disconnect all external devices.
- Pack your iPAQ and all external devices (such as the cradle, cords, and cables) in their original packing boxes or in similar packaging with sufficient packing material to protect them.

# *appendix b*

## CHARACTER RECOGNIZER

Using Character Recognizer, you can write characters directly on your iPAQ H3000 screen with your stylus, just as you would on a piece of paper. The characters you write are translated into typed text. Use Character Recognizer anywhere you want to enter text, for example, to write a note or to fill in fields in a dialog box.

The default writing mode for Character Recognizer is lowercase (Jot-compatible) mode. In this mode, you write characters in lowercase. The chart at the end of this appendix contains examples of how to write characters in lowercase mode. You can also choose to write in uppercase (Graffiti-compatible) mode. In this mode, you write characters in uppercase. If you prefer to write in uppercase mode, tap Uppercase Mode in Options on the input method menu. Whether a letter appears in uppercase or lowercase when it is converted to typed text depends on where in the input panel you write it, not on the mode you have selected.

The Character Recognizer input panel is divided into three writing areas. Letters written in the left area (labeled ABC) creates uppercase letters, and letters written in the middle area (labeled abc) creates lowercase letters. Use the right area (labeled 123) for writing numbers, symbols, special characters, and punctuation.

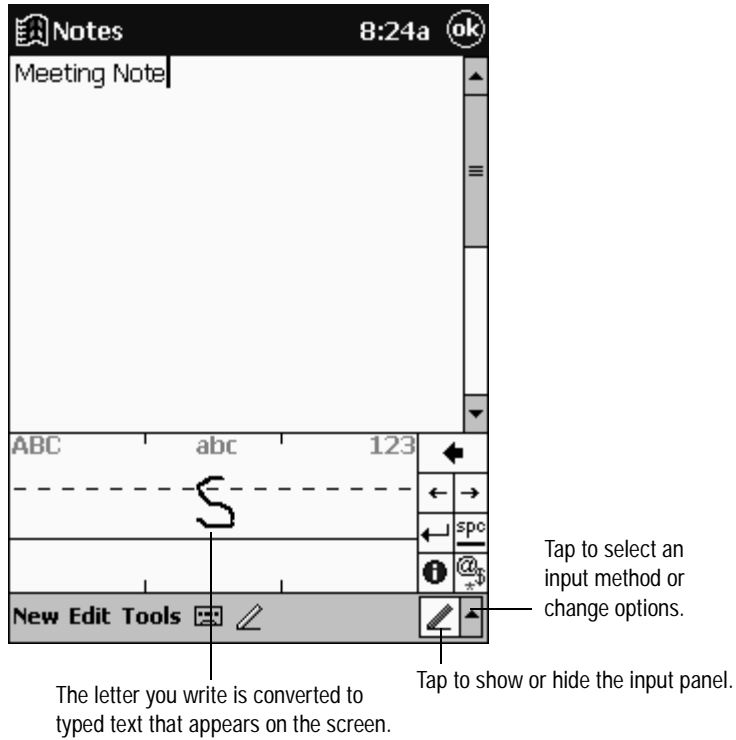

The following chart is a partial display of the characters you can write while in lowercase mode (the dot on each character is the starting point for writing). Remember that even though you write a letter in its lowercase form, the case of the text that is displayed depends on where you write the letter. For example, if you write a lowercase “a” in the ABC area, an uppercase “A” is displayed on the screen.

Letter Area				Number/Punctuation Area											
A	aa			N	h			0	0			)	)		
B	bb			O	oo			1	1			+	+		
C	C			P	p			2	2 2			*	X	∞	
D	d			Q	q			3	3			/			
E	e			R	r			4	L 4 4 4 L			\			
F	f			S	s			5	5 5 5			?	?	?	
G	g			T	t 7 7 7 t			6	6			!	!		
H	h			U	u			7	7			@	@		
I	i			V	v			8	8			&	4		
J	J J			W	w			9	9			‘	‘		
K	k K k α			X	x			>	>			“	“		
L	L L l			Y	y			·	·			-	-		
M	m			Z	z			(	(						

space	—
back space	—

enter	—
back space	—

For more information on using Character Recognizer and for demos of all characters, tap  on the Character Recognizer input panel.



# *appendix c*

## REGULATORY NOTICES

### Regulatory Agency Identification Numbers

For regulatory identification purposes your product is assigned an Agency Series number. The Agency Series number for this product is Series PE2030\*. This series number should not be confused with the marketing name (Compaq iPAQ H3000 Pocket PC).

The following accessories have been evaluated for use with your iPAQ H3000 Pocket PC. These Compaq-approved accessories can be identified by their assigned series numbers listed below. To ensure continued reliable and safe operation of your iPAQ H3000, use only the accessories listed below with your iPAQ H3000.

<u>Accessories</u>	<u>Agency Series Number</u>
USB Cradle	PE2035*
Serial Cradle	PE2035*
CF Card Expansion Pack	PE2036B
PCMCIA Card Expansion Pack	PE2036C*
Bluetooth Expansion Pack	PE2036D

\* Intended for use with Listed Class 2, rated 5 Vdc, minimum 2A power supply unit.

# Federal Communications Commission Notice

This equipment has been tested and found to comply with the limits for a Class B digital device, pursuant to Part 15 of the FCC Rules. These limits are designed to provide reasonable protection against harmful interference in a residential installation. This equipment generates, uses, and can radiate radio frequency energy and, if not installed and used in accordance with the instructions, may cause harmful interference to radio communications. However, there is no guarantee that interference will not occur in a particular installation. If this equipment does cause harmful interference to radio or television reception, which can be determined by turning the equipment off and on, the user is encouraged to try to correct the interference by one or more of the following measures:

- Reorient or relocate the receiving antenna.
- Increase the separation between the equipment and receiver.
- Connect the equipment into an outlet on a circuit different from that to which the receiver is connected.
- Consult the dealer or an experienced radio or television technician for help.

## Modifications

The FCC requires the user to be notified that any changes or modifications made to this device that are not expressly approved by Compaq Computer Corporation may void the Reference authority to operate the equipment.

## Cables

Connections to this device must be made with shielded cables with metallic RFI/EMI connector hoods in order to maintain compliance with FCC Rules and Regulations. Declaration of Conformity for products marked with the FCC logo - United States only. This device complies with Part 15 of the FCC Rules. Operation is subject to the following two conditions: (1) this device may not cause harmful interference, and (2) this device must accept any interference received, including interference that may cause undesired operation.

For questions regarding your product, contact:

Compaq Computer Corporation  
P. O. Box 692000, Mail Stop 530113  
Houston, Texas 77269-2000  
Or, call 1-800-652-6672 (1-800-OK COMPAQ)

For questions regarding this FCC declaration, contact:

Compaq Computer Corporation  
P. O. Box 692000, Mail Stop 510101  
Houston, Texas 77269-2000  
Or, call (281) 514-3333

To identify this product, refer to the Part, Series, or Model number found on the product.



## Canadian Notice

This Class B digital apparatus meets all requirements of the Canadian Interference-Causing Equipment Regulations.

## Avis Canadien

Cet appareil numérique de la classe B respecte toutes les exigences du Règlement sur le matériel brouilleur du Canada.

## European Union Notice

Products with CE marking comply with both the EMC Directive (89/336/EEC) and the Low Voltage Directive (73/23/EEC) issued by the Commission of the European Community.

Compliance with these directives implies conformity to the following European Norms (in brackets are the equivalent international standards):

- EN55022 (CISPR 22) - Electromagnetic Interference
- EN50082-1 (IEC801-2, IEC801-3, IEC801-4) - Electromagnetic Immunity
- EN 60950 (IEC60950) - Product Safety

## Battery Warning



This computer contains an internal lithium polymer battery pack. To reduce the risk of fire or burns, do not disassemble, crush, puncture, short external contacts, or dispose of in fire or water. Replacement should only be done by a Compaq authorized service provider using the Compaq spare part for this computer.

## Airline Travel Notice

Use of electronic equipment aboard commercial aircraft is at the discretion of the airline.

# Power Cords

If you were not provided with a power cord for your iPAQ 3000 Pocket PC or for an AC power accessory intended for use with your device, you should purchase a power cord that is approved for use in your country.

The power cord must be rated for the product and for the voltage and current marked on the product's electrical ratings label. The voltage and current rating of the cord should be greater than the voltage and current rating marked on the product. In addition, the diameter of the wire must be a minimum of 0.75 mm<sup>2</sup>/18AWG, and the length of the cord must be between 5 feet (1.5 m) and 6.5 feet (2 m). If you have questions about the type of power cord to use, contact your Compaq authorized service provider.

A power cord should be routed so that it is not likely to be walked on or pinched by items placed upon it or against it. Particular attention should be paid to the plug, electrical outlet, and the point where the cord exits from the product.



To reduce the risk of personal injury, electric shock, fire, or damage to the equipment:

- Do not disable the power cord grounding plug. The grounding plug is an important safety feature.
- Plug the equipment into a grounded (earthed) electrical outlet that is easily accessible at all times.
- Disconnect power from the equipment by unplugging the power cord from the electrical outlet.
- Do not place anything on power cords or cables. Arrange them so that no one may accidentally step on or trip over them.
- Do not pull on a cord or cable. When unplugging from the electrical outlet, grasp the cord by the plug.

# *appendix d*

## HARDWARE SPECIFICATIONS

### System Specifications

<b><u>Feature</u></b>	<b><u>iPAQ 3000 Series</u></b>
<b>Processor</b>	StrongARM SA-1110
<b>Memory</b>	SDRAM
<b>Display</b>	Color TFT, 240 x 320 pixels, 4K-color support, .24-dot pitch
<b>Backlight</b>	5-level brightness, light sensor for automatic adjustment of brightness level
<b>Audio</b>	Speaker, 3.5 mm stereo headphone jack
<b>Infrared</b>	IrDA, data transfer up to 115.2 Kb per second
<b>Communications</b>	Communication port, Expansion Pack connector
<b>Indicators</b>	3 mode alarm notification: flashing green LED, tone, pop-up message. Charge light: flashing/solid amber LED
<b>Battery</b>	Lithium Polymer

# Physical Specifications

	<u>iPAQ H3000 Pocket PC</u>		<u>iPAQ H3000 with Basic Style Pack</u>	
	<u>US</u>	<u>Metric</u>	<u>US</u>	<u>Metric</u>
<b>Height</b>	5.1 in	130 mm	5.2 in	131.6 mm
<b>Width</b>	3.3 in	83.5 mm	3.4 in	86.6 mm
<b>Depth</b>	.63 in	15.9 mm	.70 in	17.8 mm
<b>Weight</b>	6 oz	170 g	TBD	TBD

# Operating Environment

		<u>US</u>	<u>Metric</u>
<b>Temperature</b>	Operating	32° to 104°F	0° to 40°C
	Nonoperating	-4° to 140°F	-20° to 60°C
<b>Relative humidity (non-condensing)</b>	Operating	20 to 90%	20 to 90%
	Nonoperating	20 to 90%	20 to 90%
<b>Maximum altitude (un-pressurized)</b>	Operating	15,000 ft	4,572 m
	Nonoperating	40,000 ft	12,192 m